

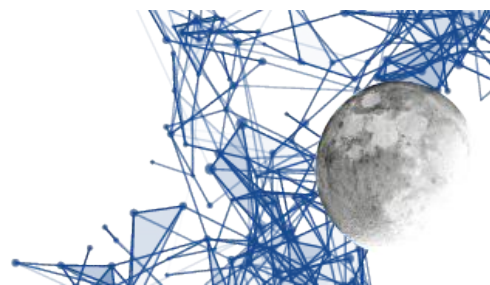

**EladRemote**  
*Operations manual*  
v1.79



## Main index

Product overview.....	6
Product needs and installation.....	6
Product capabilities.....	6
Normal operations.....	7
Running the program.....	7
Warning on the product structure.....	7
Main screens.....	8
Main controls usage.....	9
Encoder usage.....	9
Frequency management.....	9
Frequency step management.....	10
Reception operations.....	11
FFT setting commands.....	12
Transmission operations.....	13
CW transmission operations and settings.....	13
Operations with other programs.....	15
Other operations and screens.....	16
Bands and frequency screen.....	16
Modulations subscreen.....	16
Advanced operations.....	17
Main settings screen.....	17
DUO related settings.....	17
Switches.....	18
Encoders.....	18
Link controls.....	19
Tmate and function keys setting.....	20
Hardware setting.....	21
Graphic representation and performance.....	23
Poorly defined monitors.....	23
Slow graphics cards.....	24
Touch screens.....	25
Installation.....	26
Installation on Linux systems.....	26
Program download.....	26
Installation of support libraries.....	26
Program compilation and installation.....	26
Preparation of the execution environment.....	27
EladRemote first launch and configuration.....	27
EladRemote normal launch process.....	27
Installation on Windows 64 bit systems.....	28
Updating a previous version.....	28
Preparation of the support environment.....	28



ELAD:  
**RADIOLUTIONARY.**

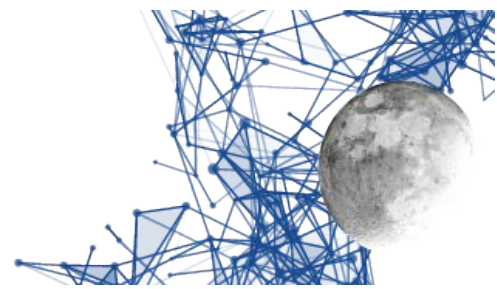

Installation of EladRemote.....	36
EladRemote first launch and configuration.....	38
EladRemote normal launch process.....	38
Installation on Windows 32 bit systems.....	39
Updating a previous version.....	39
Preparation of the support environment.....	39
Installation of EladRemote.....	47
EladRemote first launch and configuration.....	49
EladRemote normal launch process.....	49
Web folders schematics.....	50
Connections.....	51
How to connect FDM DUO and DUO ART.....	51

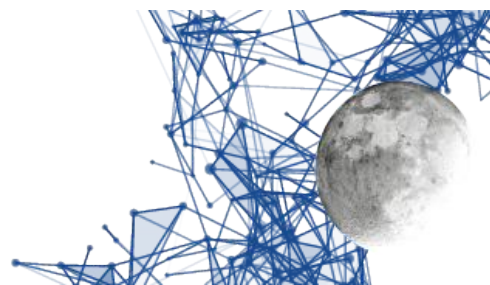

*Picture index*

The Desktop icons to launch EladRemote.....7

Expert screen for controlling the apparatus.....8

The "Bare" screen minimizes the number of visible controls.....8

The main receiver settings.....11

Position of LPF, ATT and controls related to FFT.....12

Transmission controls in the Expert screen (left) and Bare (right).....13

Band setting screen, modes, frequencies.....16

Setting the demodulation / emission mode.....16

Settings screen.....17

DUO setting commands, in the settings screen.....17

The controls related to data communication.....19

Network parameters in "Expert View" .....19

Network parameters in "Bare View" .....20

Function keys and TMATE setting screen.....20

Hardware setting screen.....21

Settings screen with "Antialiased" fonts and "Draw" Graphic Design.....23

Expert view with "Draw" Graphic design.....24

Bare view with "Draw" Graphic design.....24

Touch modality of Expert view.....25

Installation program – setup launch.....29

Installation program - initial screen.....29

Installation program - choice of operations.....30

Installation program – installation folder.....30

Installation program - where to store the installation files.....31

Installation program - network configuration for downloading.....31

Installation program - choice of the mirror.....32

Installation program - download of the list of installable packages.....32

Installation program - possible updated version notice available.....33

Installation program - list of packages to be installed.....33

Installation program - confirm packages to install.....34

Installation program - progress of operations.....34

Installation program - possible restart request.....34

Installation program - last installation phase.....35

Installation program - menu and icon creation.....35

EladRemote program installation – open Download folder.....36

EladRemote program installation – choose the right location.....37

EladRemote program installation – installation finished.....37

The Desktop icons to launch EladRemote.....38

Installation program – setup launch.....40

Installation program - initial screen.....40

Installation program - choice of operations.....41

Installation program – installation folder.....41

Installation program - where to store the installation files.....42



ELAD:  
**RADIOLUTIONARY.**

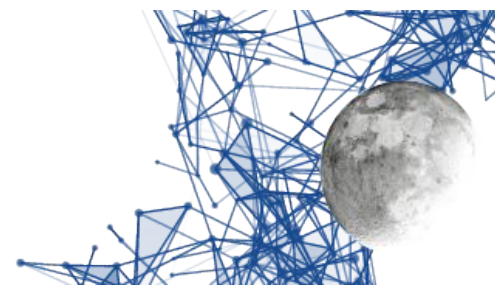

Installation program - network configuration for downloading.....	42
Installation program - choice of the mirror.....	43
Installation program - download of the list of installable packages.....	43
Installation program - possible updated version notice available.....	44
Installation program - list of packages to be installed.....	44
Installation program - confirm packages to install.....	45
Installation program - progress of operations.....	45
Installation program - possible restart request.....	45
Installation program - last installation phase.....	46
Installation program - menu and icon creation.....	46
EladRemote program installation – open Download folder.....	47
EladRemote program installation – choose the right location.....	48
EladRemote program installation – installation finished.....	48
The Desktop icons to launch EladRemote.....	49
FDM DUO / DUO ART connection schematics as per DUO ART Manual.....	51

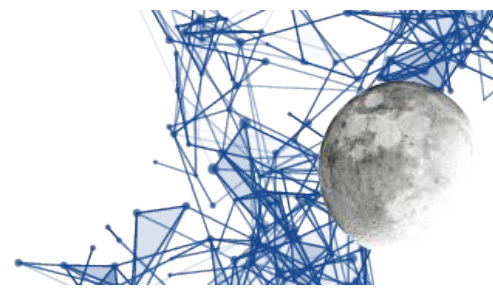

## Product overview

EladRemote is a program that allows a computer to control a DUO ART and its connected DUO through a network connection.

## Product needs and installation

To run EladRemote some hardware is needed:

- ELAD FDM DUO
- ELAD DUO ART 60 or ELAD DUO ART 120
- USB HUB
- PC running Linux or Windows operating system
- various cables

FDM DUO and DUO ART must be connected as outlined in **Connection** section at the end of this manual.

DUO ART must be connected to a network using the rear RJ45 network connector. Also the PC must be connected to a network, obviously the two devices must be able to talk each other.

On the PC the related software must be installed. The installation varies with the type of operating system the computer uses. Detailed instructions could be found in the proper **Installation** section.

Once installed, EladRemote can be started in the usual way the chosen operating system starts all programs. This means, for example, that on Windows there is an icon on the Desktop to start the program. To see this in detail, please refer to the proper Program **Start** section.

**BEWARE:** EladRemote is a complete different product from SW2. EladRemote is not a SDR program, it is a remotization program intended for the use with ELAD FDM DUO **together** with ELAD DUO ART (60 or 120). To use EladRemote, the FDM DUO USB cables must be connected with the DUO ART and **NOT** directly with the PC.

## Product capabilities

EladRemote is a program that mimics the front panel of a radio transceiver, allowing all the normal operations of a transceiver, with the main difference that it could be done in a different physical location and with the convenience of having most used commands ready and visible.

To be precise: with EladRemote it is possible to tune the radio on a band/frequency, setting all the related stuff, as, for example, modulation, bandwidth, gain, noise control. Then it is possible to put the transceiver in TX mode to establish a two way contact.

EladRemote is able to full control practically all the aspects of both FDM DUO and DUO ART, making quick and friendly also their internal settings.

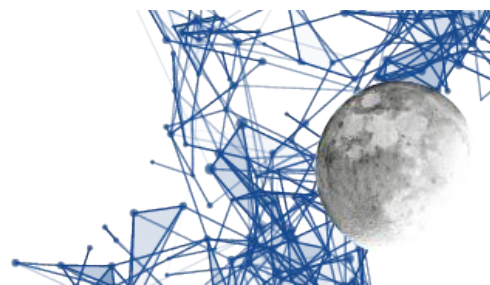

## Normal operations

### Running the program

Please refer to the sections Initial start-up and configuration of EladRemote and Startup of EladRemote at the end of the installation instructions for the related platform: it is necessary to distinguish between a first launch that allows you to enter the parameters of the DUO ART to be checked, and a second phase that no longer requires manual intervention.

In general in Linux the program will be launched with the name using a special shell from the command line:

EladRemote.sh

In Windows environments the installation suggests to install the launch commands that will appear as icons on the Desktop.



*The Desktop icons to launch EladRemote*

### Warning on the product structure

EladRemote is a graphic program that allows communication and remote control of a DUO ART and its connected DUO.

It is highly configurable, at four distinct levels:

1. From the graphical interface you can:
  - Customize the uses of the function keys as well as any connected TMATE.
  - Change the operating parameters (audio compression, buffering, themes).
  - Select the interface language.
  - Decide the complexity of the management screen.
  - Change the type of graphic management to adapt to video cards of different levels and power (drawing / graphics and / or antialiasing).
2. From the configuration file, you can:
  - Change the positions and dimensions of the controls and graphic elements.
  - Change the font size and styles of the lettering.
3. By replacing files you can:
  - Change the fonts.
  - Change the graphics of buttons and indicators (Smeter, Power Meter).
  - Add localization in different languages.
4. By programming you can:
  - Write also individual functions that replace / add both graphic and communication features.

For all these reasons, in this manual we will refer to the "vanilla" version, that is the one available on the ELAD website, without any customization.



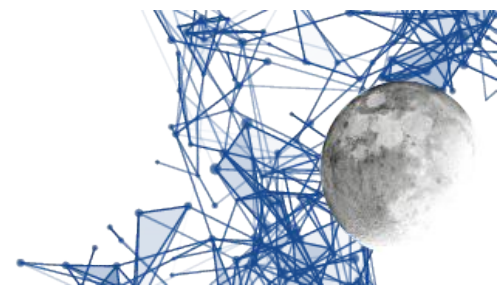

## Main screens

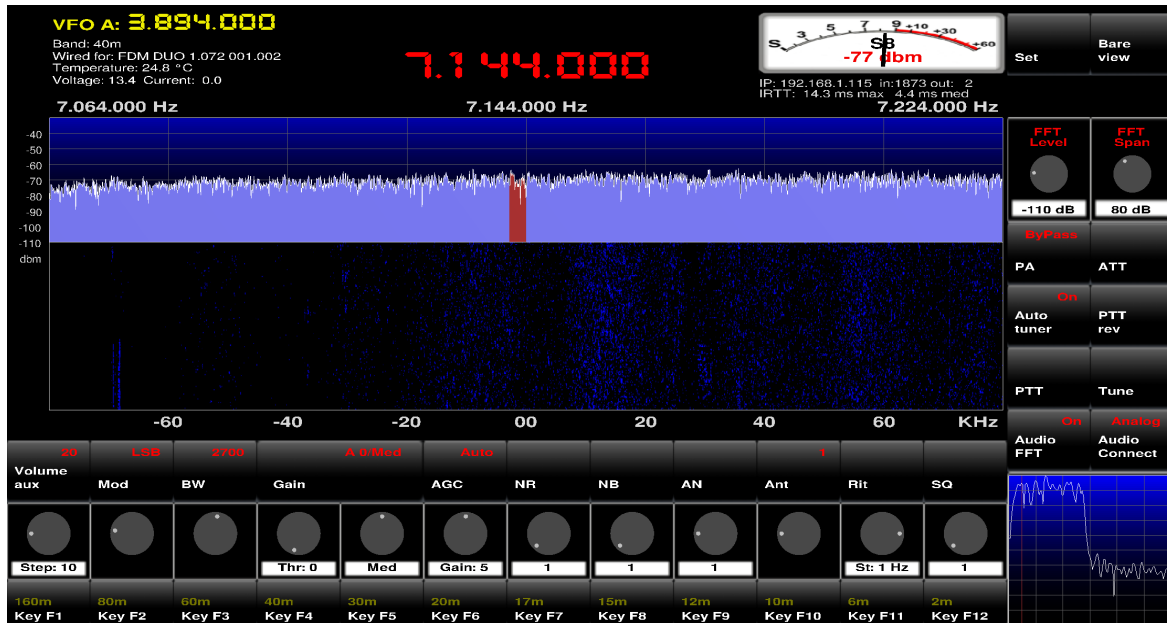

*Expert screen for controlling the apparatus*

There are several different screens available; the first, that normally appears at the first run of the program, is called "Expert" (or "Exp"), and allows almost complete control of the apparatus from immediately visible controls. For those who want less controls to have more space for the waterfall, there is a "Bare" screen that minimizes the number of controls on display. Switching between those two screens is done by clicking in the upper right button labeled Bare view / Exp view.

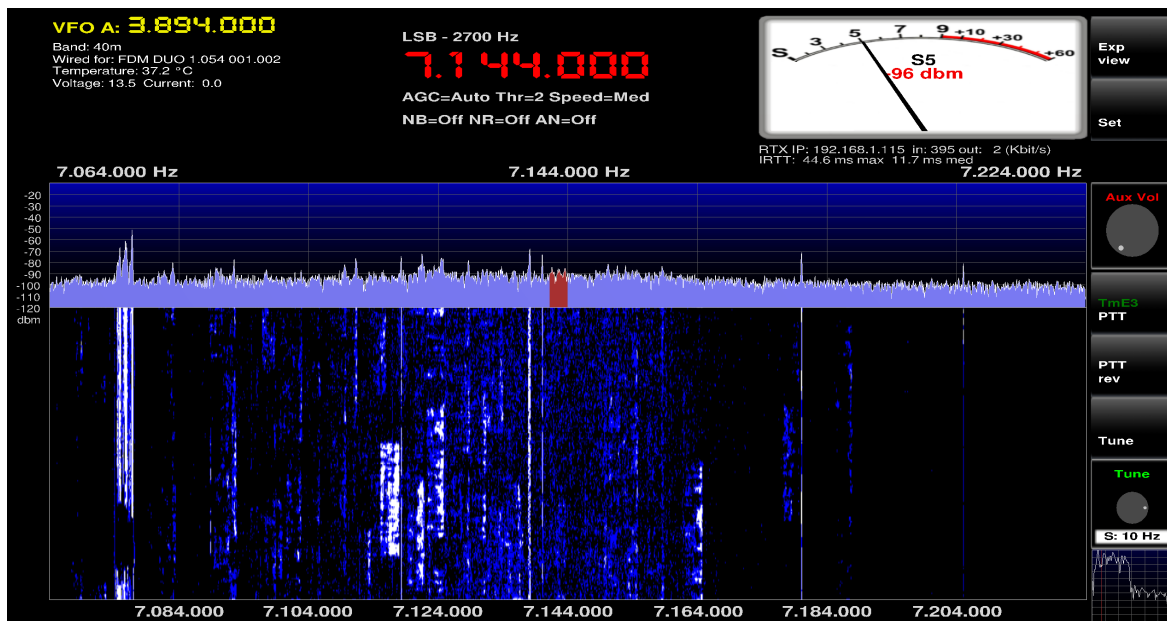

*The "Bare" screen minimizes the number of visible controls*



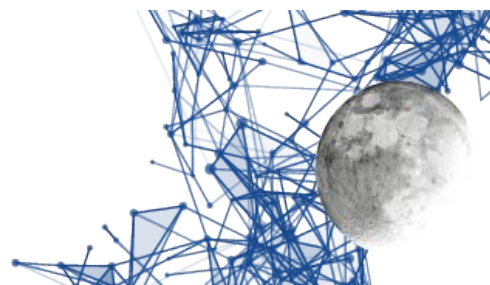

## Main controls usage

### Encoder usage

Many adjustments are made via the encoders. These have two modes of operation, depending on whether the touch mode is activated or not.

If the touch mode is activated you will see two arrows: the value is increased by tapping the arrow pointing upwards and decreased by tapping the downward-pointing arrow.

If the touch mode is active then you can change the value by rotating the mouse wheel when the pointer is in the encoder area. If required, the value of the rotation increment can be modified by clicking with the left or right mouse buttons. Clicking with the left button reduces the value of the increment, while the right click increases the value of the increment.

### Frequency management

One of the most important features of the SDR is the 'frequency agility' or the ability to manage the frequency very effectively, helped by the fact that FFT and waterfall allow you to identify the interesting signals at a glance.

Obviously there is always the possibility to manage the frequency in the traditional way, and therefore you can operate in various ways:

- Using the TUNE knob of the TMATE, if you do not decide to enable it for other adjustments.
  - The frequency increase can be set, see the next paragraph, and it is the same for all methods.
- Using the "Main frequency" encoder in the "Expert" screen.
  - The encoder rotation is obtained by rotating the mouse wheel while the mouse is in the encoder area.
  - The frequency increase can be set, see next paragraph, and it is the same for all methods.
- Using the "Tune" encoder in the "Bare" screen.
  - The encoder rotation is obtained by rotating the mouse wheel while the mouse is in the encoder area.
  - The frequency increase can be set, see the next paragraph, and it is the same for all methods.
- Using the "left arrow" and "right arrow" keys on the keyboard.
  - The frequency increase can be set, see next paragraph, and it is the same for all methods.
- By clicking on a frequency in the waterfall.
  - You can click on both the waterfall area and the FFT area, either with the right mouse button or with the left mouse button.
  - When the key is pressed, the frequency is **not** changed but a line appears indicating the chosen frequency, frequency that is also displayed on the screen.
  - The row indicating the frequency is red or green depending on whether the mouse is on the waterfall or FFT area: this serves as security.

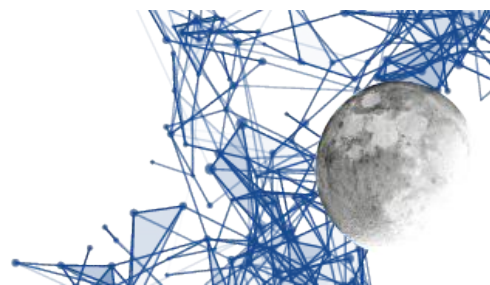

- If you release the key when the line is red then you change frequency, if you release it when the line is green then the frequency is not changed (this would be a security if you mistakenly clicked on the waterfall / FFT area).
- The frequency is rounded to the nearest **Auto Snap increment**.
- By turning the mouse knob with the mouse positioned on waterfall or FFT.
  - The frequency increase can be set, see next paragraph, and it is the same for all methods.
- By setting the frequency with the numeric keys that appear on the screen when you click on the frequency (modes setting screen, bands, frequencies).
  - ATTENTION: if the RIT is on, the use of the keypad sets the RIT and not the frequency.
- Using the numeric keys of the PC keyboard.
  - ATTENTION: if the RIT is on, the use of the keypad sets the RIT and not the frequency.
  - You can set the frequency in Hertz by entering the digits and setting it with "ENTER", or in kHz writing only the kHz and then pressing the "k" key.
  - In case a digit is wrong, it can be deleted by pressing the "backspace" key.

## Frequency step management

This can also be done in several ways:

- By clicking with the left / right mouse button in the "Main Frequency" encoder area of the "Expert" screen.
  - A click with the left button makes the 1/10 increment, up to 1Hz.
  - A click with the right button increases the increment of 10 times, up to 10 MHz.
- By clicking with the left / right mouse button in the "Tune" encoder area of the "Bare" screen.
  - A click with the left button makes the 1/10 increment, up to 1Hz.
  - A click with the right button increases the increment of 10 times, up to 10 MHz.
- Using the "down arrow" and "up arrow" keys on the numeric keypad.
  - Pressing the "down arrow" makes the 1/10 increment up to 1Hz.
  - Pressing the "arrow up" increases the increment by 10 times, up to 10 MHz.

The "Auto Snap" value, used when setting the frequency by clicking on the Waterfall, can be set using "Auto Snap" encoder in Settings screen.

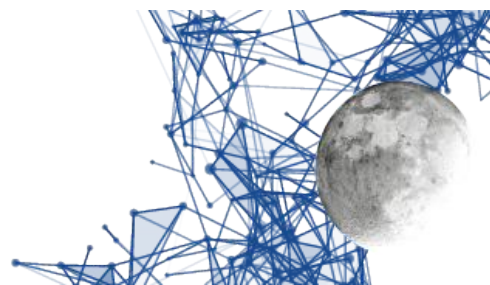

## Reception operations

These are the commands that allow you to change the behavior of the receiver and that act, with CAT commands and through the data network and the DUO ART, directly on the settings of the FDM DUO.

In the Expert screen, they are at the bottom of the screen, as shown in the image below.

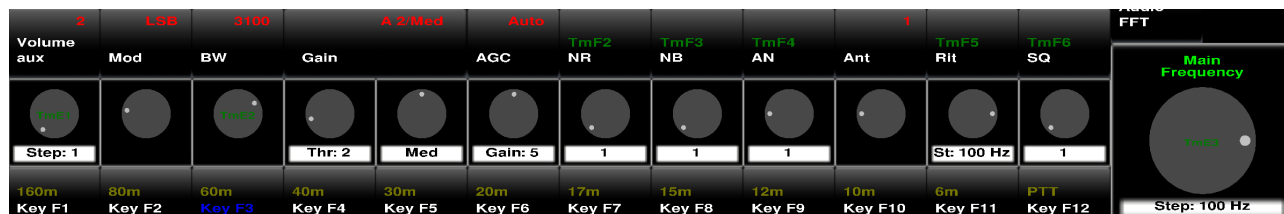

*The main receiver settings*

These commands are mainly composed of a button and an encoder: the button allows to include / exclude the control, while the encoder allows to adjust the value.

In the label below, the encoder indicates the step or the value of the control.

The green lettering indicates the activation of the command from TMATE or Function keys.

The red writing indicates the value actually entered.

- **Aux Volume:** adjusts the volume of the audio passed to the application, in red the value (if audio is not silenced), on the label the adjustment step (1 or 10) that can be set by clicking with the right button of the mouse on the encoder area.
- **Mod:** modulation used; the word "TmE1" indicates that it can be changed by rotating the E1 encoder of the TMATE.
- **BW:** adjusts the bandwidth (varies with modulation); the label "TmE2" indicates that the band can be changed by rotating the E2 encoder of the TMATE.
- **Gain:** Gain in IF. **ATTENTION:** the button has no uses except for the indication of the name of the control. The two encoders below vary the Threshold and speed values and are active only if AGC is in Auto position.
- **AGC:** Switches the IF gain control between Automatic and Manual. **WARNING:** the encoder below, which changes the gain value, is active only if AGC is in Manual position.
- **NR:** Noise Reduction. The label TmF2 indicates that the NR can be switched with the F2 button of the TMATE. The encoder below allows to change the value of the reduction and is active only with the NR inserted.
- **NB:** Noise Blanker. The label TmF3 indicates that the NB can be switched with the F3 button of the TMATE. The encoder below allows to vary the value of the reduction and is active only with NB inserted.
- **AN:** Auto Notch. The label TmF4 indicates that the AN can be switched with the F4 button of the TMATE. The encoder below allows to change the value of the reduction and is active only when AN is inserted.
- **Ant:** which antenna of the DUO ART is used. **ATTENTION:** the button is inactive, only the encoder below works. The antenna can be changed automatically by the DUO ART depending on the internal settings.

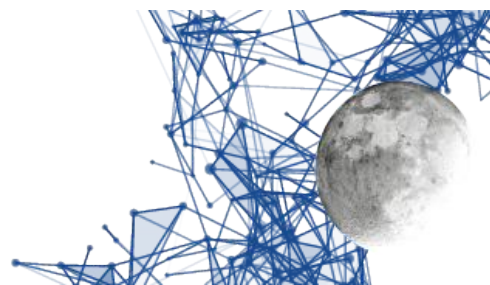

- Rit: Receiver Incremental Tuning. The label TmF5 indicates that it can be activated / deactivated using the FATE button of the TMATE.
- SQ: Squelch. The label TmF6 indicates that it can be activated / deactivated using the F6 button of the TMATE.

The receiver is also affected by two other important commands:

- ATT: Input attenuator. The corresponding command is on the right side of the "Expert" screen
- LPF: Low Pass Filter. Given the peculiarity of the command (disabled in the transition to the band of 2m and reactivated in the return in the bands HF / 6m) this command is placed in the settings screen.

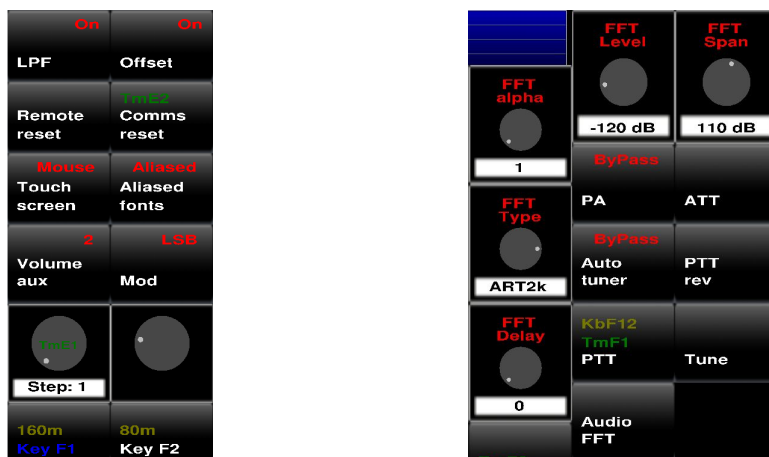

Position of LPF, ATT and controls related to FFT

## FFT setting commands

Two of these commands are present in the Expert screen, immediately available to the operator, while the others are in the settings screen.

- FFT Level: minimum level of FFT
- FFT Span: total range of FFT
- FFT Delay: every time a calculated FFT is transmitted, one is transmitted. Since the screen refresh depends on the capabilities of the PC, it is better to use this command to avoid transmitting more FFTs than they are shown. A high value could be useful for monitoring the band, low values give responsiveness to the display.
- FFT type: you can choose between three values
  1. DUO: shows the values calculated by the DUO
  2. 1k: shows a greater number of values, with a decimation to limit the effects of the applied anti aliasing windowing.
  3. 2k: shows an even greater number of values, with an even greater decimation.
- FFT alpha: alpha value for the weight average of successive FFTs (1 = disable).

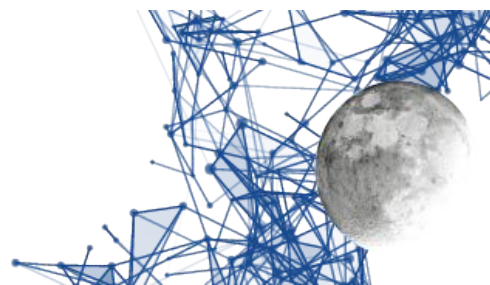

## Transmission operations

In addition to the controls just seen, there are the classic operational controls, starting from the PTT:

- PTT: if pressed with the left mouse button, it alternately activates / deactivates the transmission, if pressed with the right one it keeps the transmission active only when the key is pressed. Depending on the settings, the automatic tuner and / or linear amplifier is activated.
- The label KbF11 indicates that the function key F11 alternately sends the device in continuous transmission or in reception. Similarly, the label TmF1 indicates that the pressure on the F1 key of the Tmate keeps the equipment in transmission as long as it is pressed.
- PTT rev: like the PTT, but it exchanges VFO A / B. Basically it activates the split between the two VFOs.
- Tune: behaves differently depending on whether the antenna tuner is activated:
  - if the tuner is not activated then a click with the left mouse button activates or deactivates the transmission of the predicted power for the tune, if the click is done with the right button then, as long as the button is pressed, the DUO is placed in AM and the carrier is emitted (i.e. about half of the power set as the power of the Tx);
  - if the tuner is activated then the click with the left mouse button activates or stops the automatic tuning operations, while the right click operates like in the other mode, unless the tuner is included.
- Auto tuner: clicking with the left button activates the automatic antenna tuner or bypasses it. IMPORTANT: when the frequency is changed, the frequency setting of the selected bank of the DUO ART is defaulted.
- PA: a left click activates the linear amplifier or bypasses it. IMPORTANT: when the frequency is changed, the frequency setting of the selected bank of the DUO ART is defaulted.

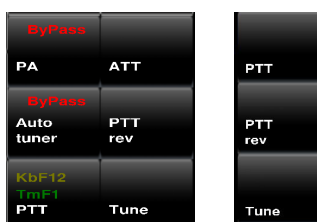

*Transmission controls in the Expert screen (left) and Bare (right)*

## CW transmission operations and settings

The program contains a keyer controlled by the control lines of a serial interface whose name can be set from the Hardware Settings Screen (center click on the “Set” button – see later in this document).

### **NOTE for Windows users (under CYGWIN or CYGWIN64):**

The device is /dev/ttySx where x is y-1 and y is the number in COMy: , so , for example, COM1: is seen as /dev/ttyS0 and COM23: is seen as /dev/ttyS22 .





ELAD:  
**RADIOLUTIONARY.**

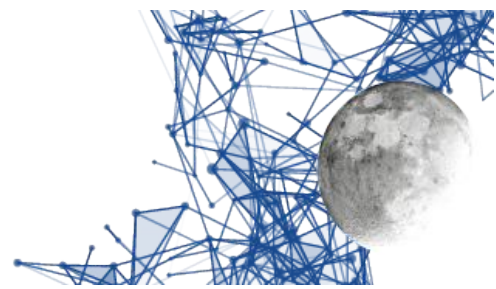

The configuration parameters in the Main Settings Screen are:

- CW Key Paddle: allows you to choose whether to work with an automatic text or paddle.
- CW WPM: sets the telegraph speed of the generation of points / lines with the paddle.

### **Key/Paddle connection**

to connect a key using Serial USB adaptor the connections are:

Straight Key:

pin 8 (CTS - sensed by program)

pin 4 (DTR - To give level to CTS)

Paddle:

pin 4 (DTR - as common)

pin 8 ( CTS - "dot" )

pin 1 ( DCD - "dash" )



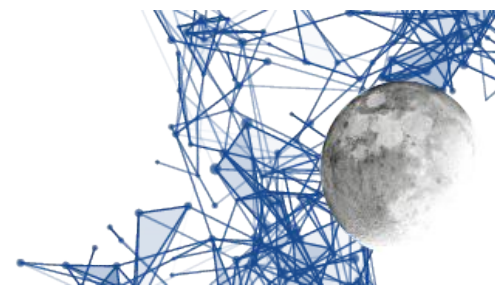

## Operations with other programs

The program has the possibility to cooperate with other programs that need to interact with the radio using audio in/out and CAT commands.

Those programs are mainly designed for using “digital modes”, and need an access to the audio signal, both to demodulate in reception and to put a modulated signal during transmission.

To allow these operations, the hardware settings screen (see later) has been modified, adding two more audio device selections, along with relative gain controls, at the same time, in the main screen, it is possible to select which couple of audio devices EladRemote uses.

The theory of operation is the following:

- when “analog” modes are used, the operator uses the devices connected with loudspeaker (or headphone) and microphone. Those devices can be selected in the hardware setup screen,
- when an “external” program for manage digital communications is used the operator uses audio devices that are “loopback” to connect audio with the external program. Also those devices can be selected using hardware setup screen,
- to adapt audio level between EladRemote and external program, two gains are provided in the hardware setup screen,
- to allow quick change between modes, in main expert screen there is a switch between the two operation modes.
- Remember that the mode of the operations is not set “automagically” so mode and bandwidth must be set appropriately.

Two words about the devices:

- in Linux appropriate loopback devices are provided by the system:
  - the CAT select can be left in the counterclockwise default position that shows the device `/dev/pts/..` that must be used by the external program to send CAT commands to EladRemote,
  - audio devices are “loopback” devices: for normal usage it is important to use the same device both for in and out audio; the external program has to use the related device (usually the device are numbered, so, if in EladRemote the device `....0` is used, in the external program it has to be used the device `....1`),
- in Windows “virtual” devices has to be used; there are many programs that realized such virtual devices
  - once the appropriate programs are downloaded, installed, and set, use the controls to set the correct device.

The “loopback” or virtual devices can be used also during “analog” operations to add mic preprocessor or audio filters: in this case the “virtual” device should be selected using the headset/mic audio controls.

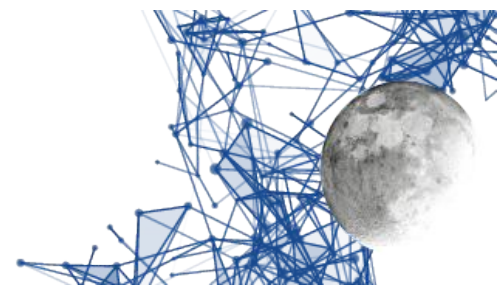

## Other operations and screens

### Bands and frequency screen

By clicking on the frequency, you can access a screen that allows you to set the bands, the emission modes, and the frequency (see image below).

This screen is especially useful in the case of touch screens because the bands can be set using the keyboard (F1-F10 keys) or the numeric keypad.

You exit this screen by clicking on the frequency again.

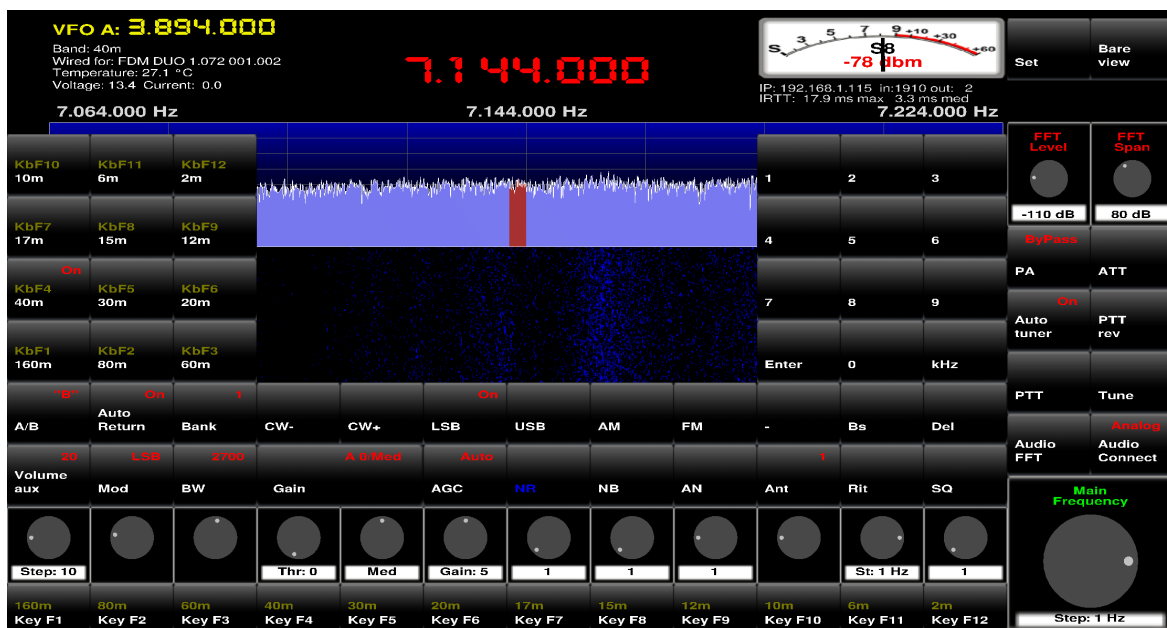

*Band setting screen, modes, frequencies*

### Modulations subscreen

By clicking on the "Mod" key (bottom - second from the left), the display of the possible modes is activated (see image below). This display is deactivated when choosing a mode or clicking on the "Mod" key.

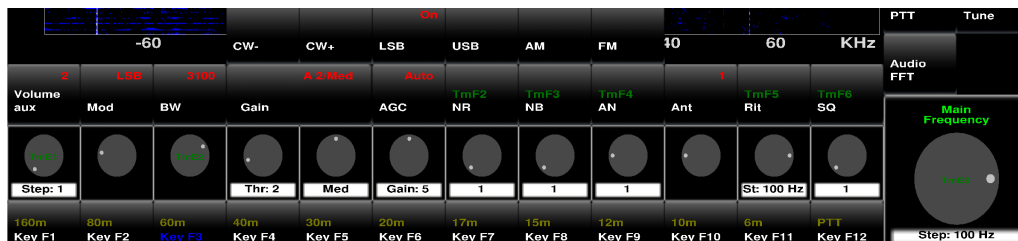

*Setting the demodulation / emission mode*

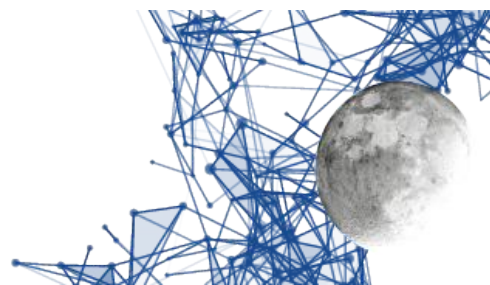

## Advanced operations

### Main settings screen

By clicking on the "Set" button (at the top, on the right of the S-meter), you can access the settings screen.

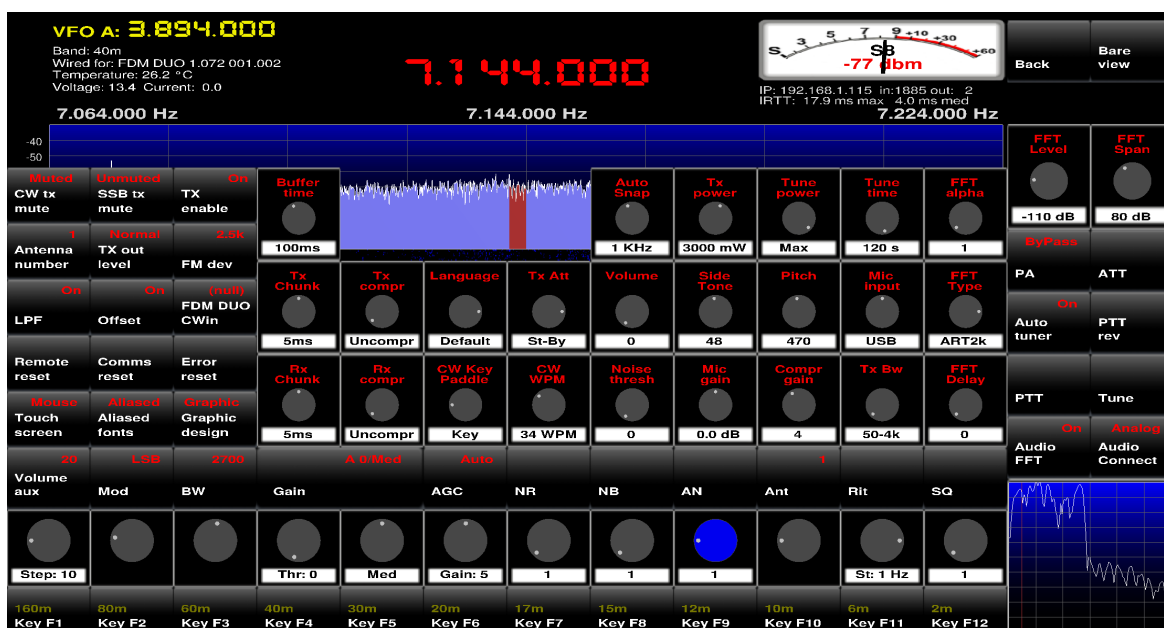

Settings screen

From this screen you can go back to the previous one by clicking on the "Bare" button at the top, on the right of the S-meter.

### DUO related settings

They are in the settings screen and are used to check the DUO aspects that make sense to be remotely controlled.

On the left there are ON/OFF type commands and, on the right, the settings. Most of these values are stored internally in the DUO.

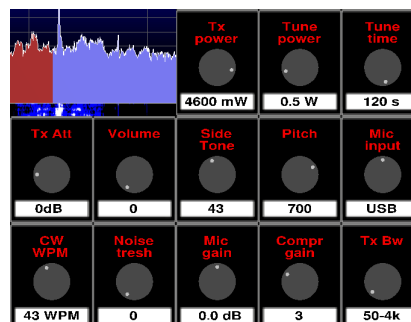
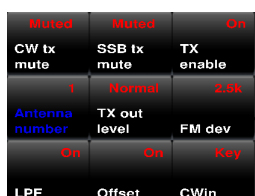

DUO setting commands, in the settings screen

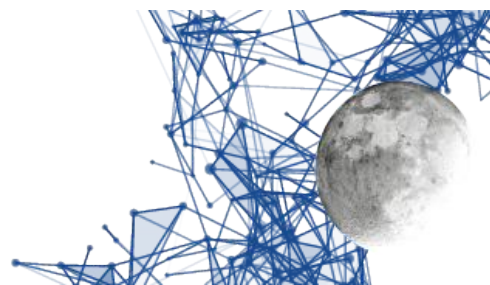

## Switches

- CW tx mute: silencing of the transmission echo in telegraphy.
- SSB tx mute: silence of the echo of the transmission in voice.
- Antenna number: if the DUO operates with 1 or 2 antennas.
- TX out level: Normal or 0dB (the latter is set automatically when the 2m band is selected and removed when it re-enters HF / 6m).
- FM dev: allows you to choose the FM deviation between 2.5 kHz and 5kHz.
- LPF: this is the previously explained Low Pass Filter (it is automatically removed when the 2m band is selected and reinserted when it re-enters HF / 6m).
- Offset: allows to set / unset the offset. The offset is set to the DUO.
- Cwin: Input CW (key / paddle). It is not used in practice (see section on transmission in CW).

## Encoders

- Tx power: output power level from Tx, adjustable in 100mW steps from 100mW to 5W (plus max power, about 8W, depending on the DUO).
- Tune power: power level during the tune phase.
- Tune time: maximum tune time that can be set on the DUO.
- Tx Att: attenuator (in DUO ART) between DUO and Linear, it is recommended to set to 2dB to optimize the power adaptation.
- Volume: the main volume of the DUO, it is recommended to set to 0.
- Side Tone: CW signal level.
- Pitch: frequency of the tone of the CW.
- Mic input: input of the audio signal to the DUO transmitter: leave on USB.
- CW WPM: telegraph speed, see chapter on the transmission in telegraphy.
- Noise threshold: microphone threshold value (see DUO manual).
- Mic gain: gain of the DUO microphone preamplifier (see DUO manual).
- Compr gain: gain of the DUO microphone compressor (see DUO manual).
- Tx Bw: bandwidth of the DUO low frequency transmission filter.

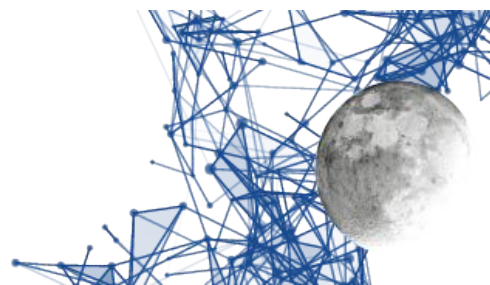

## Link controls

The purpose of EladRemote is to control the DUO ART via a TCP / IP connection. This can be done in a variety of different ways, from a local network connection to a connection via hosts connected via GPS, WiFi and more.

This means that the link may have very different characteristics both in terms of available bandwidth and latency.

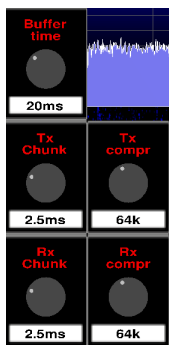

For this purpose there are controls that allow you to work on five main aspects:

- Tx compr, Rx compr: audio compression to limit bandwidth usage.
- Tx chunk, Rx chunk: size of audio packages (small = less latency, large = greater compression efficiency).
- Buffer time: buffering time (good local network suggested 20ms, suggested local network 50 ms, suggested national geographical network 100 ms, international network and / or GSM suggested 200 or 500 ms).

*The controls related to data communication*

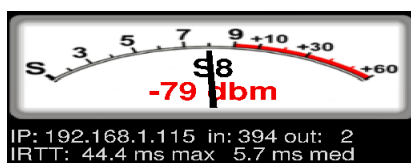

*Network parameters in "Expert View"*

In this regard, some values, useful for knowing the status of the connection, are reported:

- IP - IP address of the DUO ART
- in - average value, in kbit/s, of the input data stream (from DUO ART to EladRemote)
- out - average value, in kbit/s, of the flow of data in output (from EladRemote to DUO ART)
- IRTT max - ms of the maximum value of IRTT
- IRTT med - ms of average between the IRTT values

Attention: the *in* and *out* values do not take into account the protocol elements (IP header, TCP header, fragmentation, possible retry) but only the known elements of the websocket protocol.

IRTT is computed by periodically sending packets with timestamps: therefore it is a value fully aligned to the data, not using ICMP in separate channels and so it reflects not only the delays due to channel contention, but also those due to network errors.

The values can be reset by clicking on the S-meter area and can be useful to see how the various adjustments affect band occupancy and how the type of connection influences, above all, the latency of the signal: in this regard it must be said that the buffer time should be close, if not greater, to the maximum IRTT value to avoid "jerks" in the received audio.



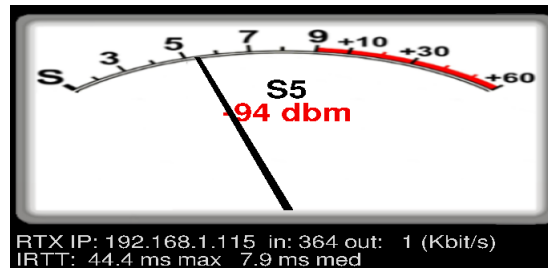
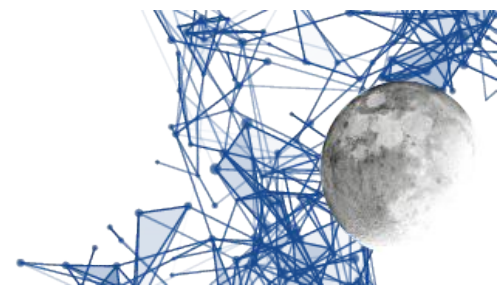

Network parameters in "Bare View"

## Tmate and function keys setting

On the "Expert" and the "Bare" screens you can click on the Set button (at the top, on the right of the S-meter) using the right mouse button to get to the settings screen of the TMATE and function keys. This screen allows you to change the functions associated with the function keys and keys and the TMATE encoders.

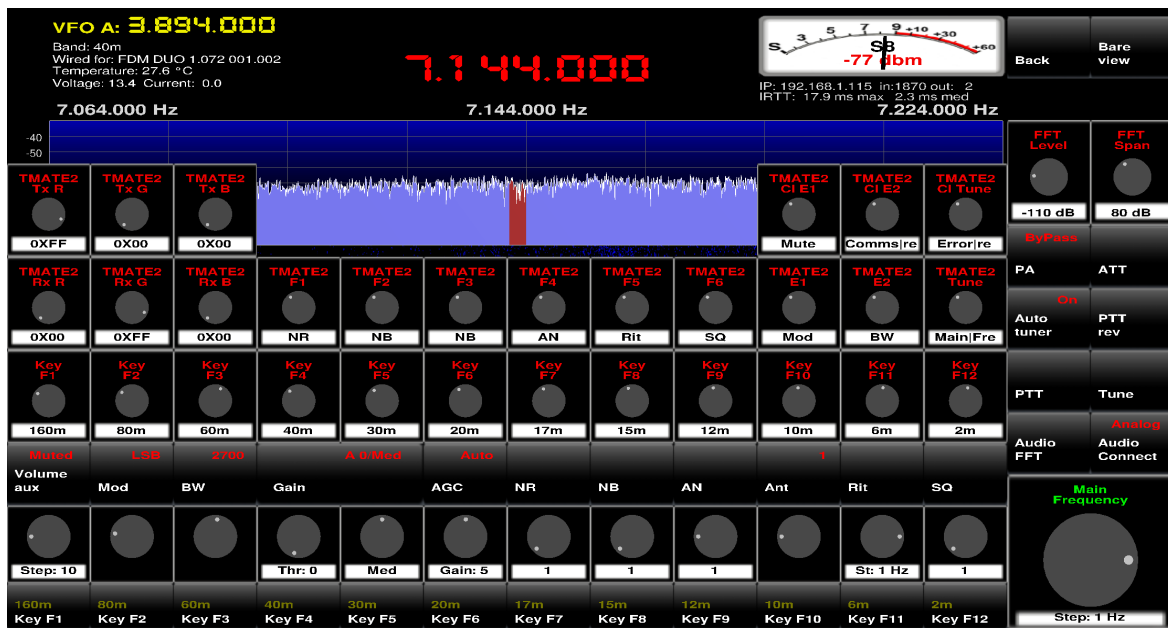

VFO A: 3.894.000  
Band: 40m  
Wired for: FDM DUO 1.072.001.002  
Temperature: 27.6 °C  
Voltage: 13.4 Current: 0.0

7.064.000 Hz      7.144.000 Hz      7.224.000 Hz

S-meter: -77 dBm

IP: 192.168.1.115 in:1870 out: 2  
IRTT: 17.9 ms max 2.3 ms med

TMATE2 Tx R	TMATE2 Tx G	TMATE2 Tx B	Spectrum						TMATE2 Cl E1	TMATE2 Cl E2	TMATE2 Cl Tune	FFT Level	FFT Span	
0xFF	0x00	0x00							Mute	Comms re	Error re	-110 dB	80 dB	
TMATE2 Rx R	TMATE2 Rx G	TMATE2 Rx B	TMATE2 F1	TMATE2 F2	TMATE2 F3	TMATE2 F4	TMATE2 F5	TMATE2 F6	TMATE2 E1	TMATE2 E2	TMATE2 Tune	ByPass	PA	ATT
0x00	0xFF	0x00	NR	NB	NB	AN	Rit	SQ	Mod	BW	Main Fre	Auto tuner	On	PTT rev
Key F1	Key F2	Key F3	Key F4	Key F5	Key F6	Key F7	Key F8	Key F9	Key F10	Key F11	Key F12	PTT	Tune	
160m	80m	60m	40m	30m	20m	17m	15m	12m	10m	6m	2m	Audio FFT	Analog	Audio Connect
Muted	LSB	2700	A 0/Mbd	Auto										
Volume aux	Mod	BW	Gain	AGC	NR	NB	AN	Ant	Rit	SQ				
Step: 10			Thr: 0	Med	Gain: 5	1	1	1		St: 1 Hz				
160m Key F1	80m Key F2	60m Key F3	40m Key F4	30m Key F5	20m Key F6	17m Key F7	15m Key F8	12m Key F9	10m Key F10	6m Key F11	2m Key F12			
													Main Frequency	
														Step: 1 Hz

Function keys and TMATE setting screen

Also from this screen you can go back to the previous one by clicking on the "Back" button at the top right of the S-meter.



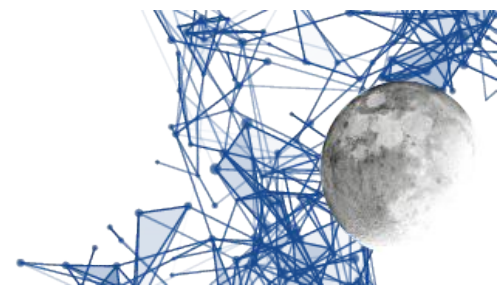

## Hardware setting

On the "Expert" and the "Bare" screens you can click on the Set button (at the top, on the right of the S-meter) using the center mouse button to get to the settings screen of the hardware devices. This screen allows you to change the devices associated with the CW keyer/paddle and the Virtual CAT (to let other programs to talk with ELAD Remote and take control of the DUO ART and FDM DUO). Also you can change the audio in (microphone) and audio out (speaker) devices, and the devices to talk to external programs.

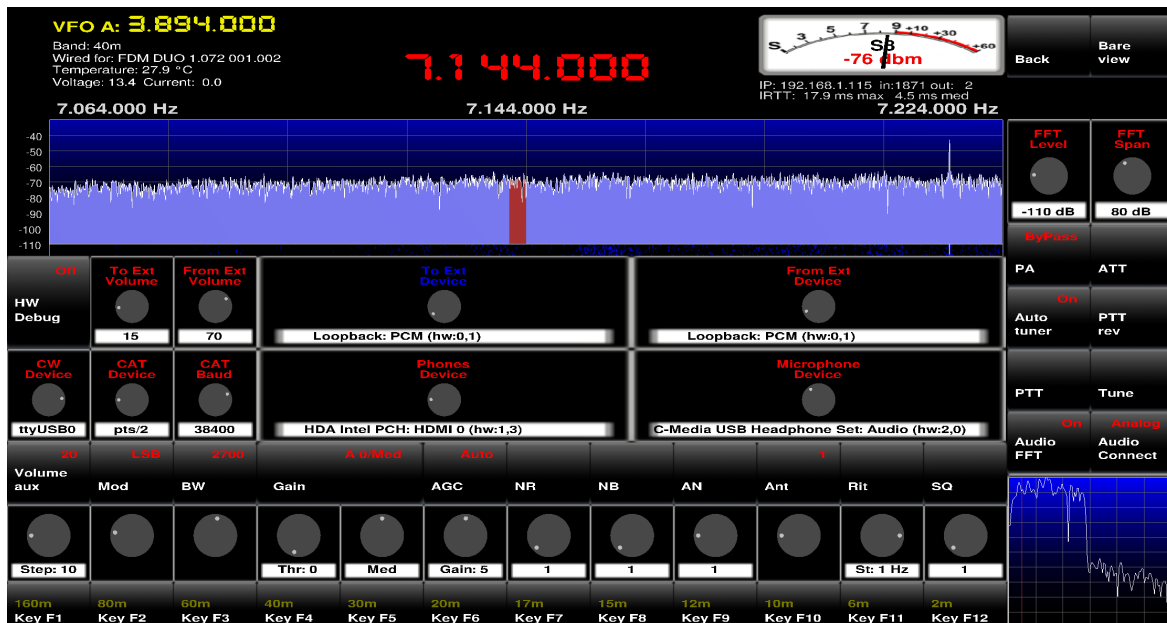

*Hardware setting screen*

Also from this screen you can go back to the previous one by clicking on the "Back" button at the top right of the S-meter.

CW Device is the serial at which a Keyer/paddle can be attached:

- in Linux the names are like "ttyUSBx" where x is a number from 0 for USB serial devices
- in Linux the names are also like "ttySx" where x is a number from 0 for native serial devices
- in Windows the names are like "ttySx" where x is a number from 0 – ttyS0 indicates the corresponding windows COM1: device, ttyS1 is linked to COM2: device, and so on.

There is no speed because only control lines are used.

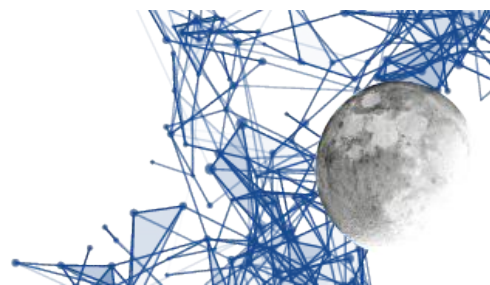

CAT Device is the (virtual) usb port to be used to connect companion programs to control the device:

In Linux ELAD Remote create a couple of “pseudo tty” devices: you can find the name of the port rotating counterclockwise the CAT control: the name displayed is the name to be used by the external program.

In Windows you need to use an external program to create a couple of virtual usb: this lead to new devices as, for example, COM12: and COM13: . In this example select ttyS11 with the control (remember that ttyS11 corresponds to COM12:) and use COM13: in the companion program.

CAT Baud is the speed of the port, with Linux “pseudo tty” interface the speed is not important, but with physical interfaces it is. Note that the other communications parameters are fixed to 8N1 (8 bit, no parity, 1 stop bit).

Phones Device is the device where the phones (or loudspeaker) is connected. The name in the box comes out from portaudio software and matches the names one can read from various control panels in the operating system settings.

Microphone Device is the device where the microphone is attached. The name in the box comes out from portaudio software and matches the names one can read from various control panels in the operating system settings.

To Ext Device and From Ext Device are controls very similar to Phones/Microphones controls. They also can be left on the same devices or in the default position: the value selected is important only for the usage of “external” programs”. At their left there are the relative gain controls which defaults are usually correct for operations.

Hardware debug switch can be of help if troubles with CAT or CW keyer, the output can be useful also to submit help requests to the ELAD staff.

**NOTE: when you activate the hardware set screen the audio is blocked. No sound is managed. This is done to allow the program to scan the audio devices. The sound returns on exit from this screen.**

**NOTE: when you add/drop an audio device the new device list is computed once when the hardware set screen is activated. The audio devices lists is updated internally from portaudio, and the process take some time, so be patient, wait a moment, activate the hardware setup screen and rotate the knobs to see the new values.**

**NOTE: if a non existing device is found in the configuration (see init.txt file) the program uses and sets the default device (in config.txt the number that identifies the default device is -1.**

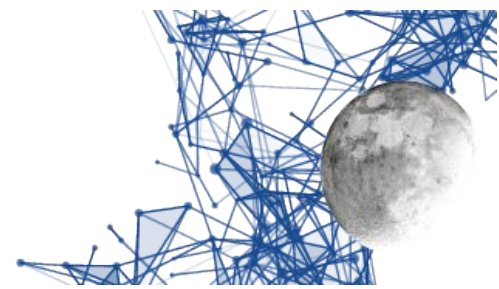

**NOTE: if in Linux you experienced problems with CAT or CW interface the command `sudo adduser youruser dialout` that add your user to the dialout group (this is correct for Ubuntu, other distributions can use different names).**

## Graphic representation and performance

EladRemote uses OpenGL as a graphical description system, which allows to exploit the performance of modern graphics cards to achieve good graphics performance.

Nevertheless, there may be situations where performance is suboptimal or insufficient, mainly due to limitations in graphics cards: this occurs more easily in laptops, where performance is often sacrificed to portability, and in older computers, but in some cases can be attributed to the lack of OpenGL video cards or outdated drivers, or, still, to dated monitors.

In any case there may be countermeasures that facilitate operations, that will be examined below.

## Poorly defined monitors

In these cases the most unpleasant thing is that the writings seem "eaten by mice" due to the limited number of pixels available.

The solution is rather trivial: in the settings screen the fonts can be set as "Antialiased" using the "Aliased Fonts" button.

As a side effect, the display of buttons and adjustments (Graphic Design) will pass from "Graphic" to "Draw", losing some embellishment but earning speed.



*Settings screen with "Antialiased" fonts and "Draw" Graphic Design*

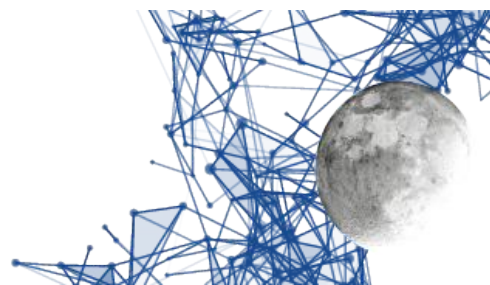

## Slow graphics cards

This can happen either because of a real slowness, or because of a driver that does not support OpenGL specifications.

Depending on the preferences and the seriousness of the problem, different choices can be made. The first is to preferably use the "Bare view" because, having fewer elements, it remains faster to display, the second is to pass the "Graphic design" from "Graphic" to "Draw" using the "Graphic design" button in the settings dialog, all without necessarily setting the fonts to "Antialiased".

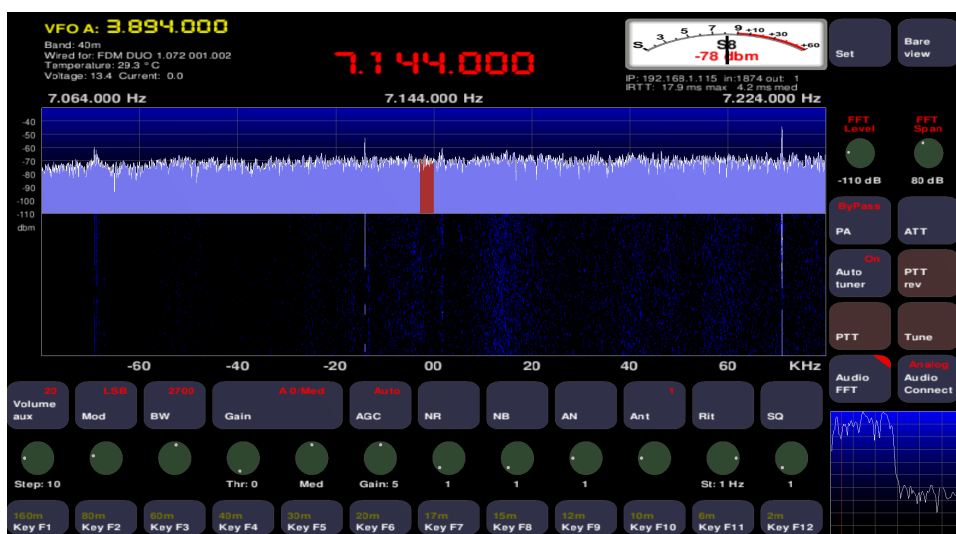

*Expert view with "Draw" Graphic design*

Obviously one solution does not exclude the other, using the screen "Bare" with the "draw" graphic design you get the best performance in terms of speed.

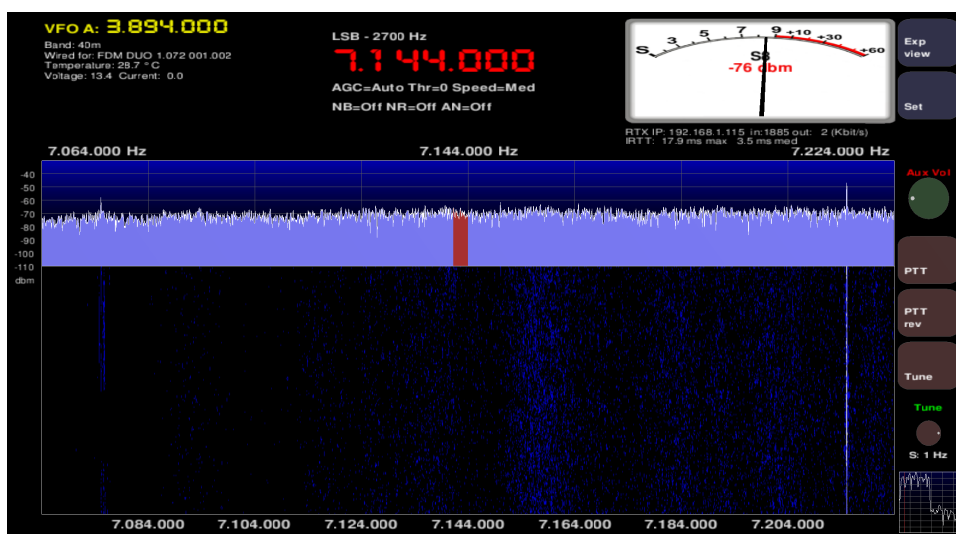

*Bare view with "Draw" Graphic design*

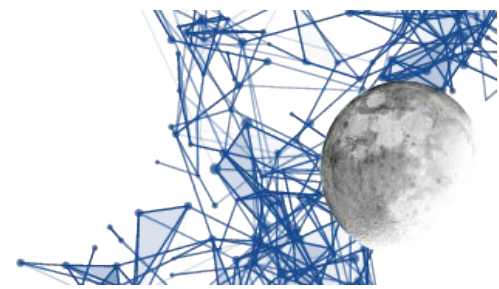

## Touch screens

In reality this is not an adaptation to a limitation, because the touch screen is something "more" at the user's disposal, but the adjustment of the controls to the touch mode of the screen, with which, despite a greater ease of use, you lose the ability to distinguish "right button" and "left button" of the mouse and, at the same time, there is no wheel.

To remedy this, the encoder controls no longer have knobs but pairs of arrows, that can be touched to increase or decrease the value connected to the control.

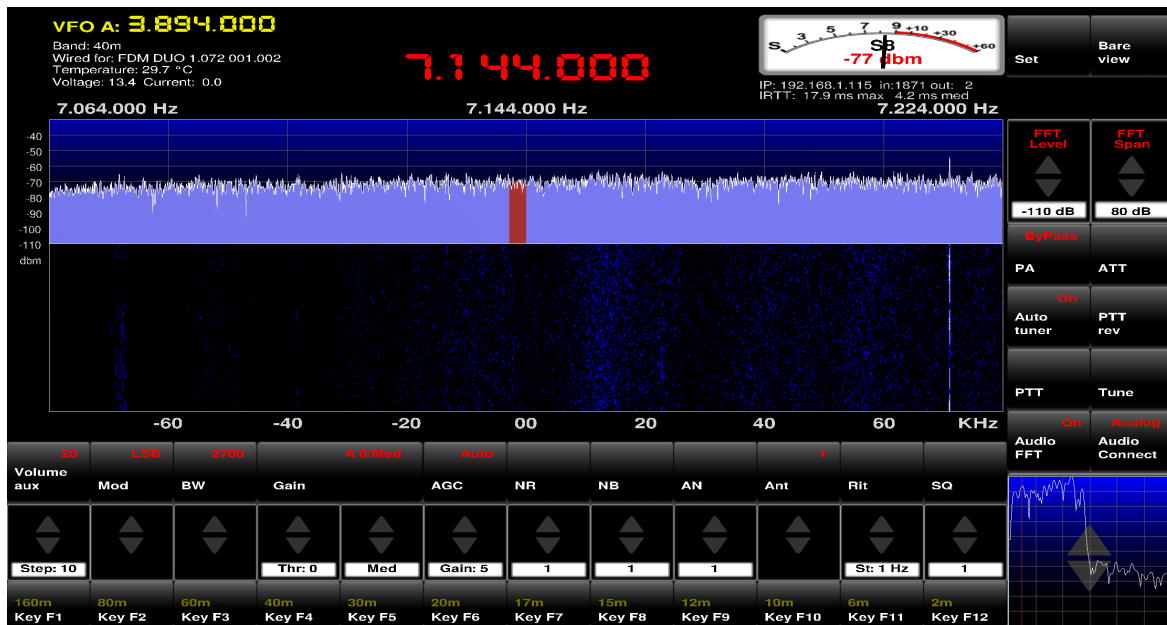

*Touch modality of Expert view*

To activate the "Touch" mode, use the settings screen and click on the "Touch screen" button to switch it from "Mouse" to "Touch".



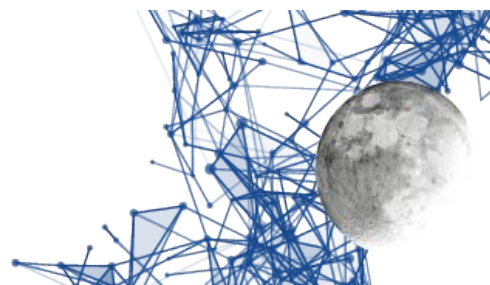

## Installation

### Installation on Linux systems

#### Program download

Using a browser, download, from the ELAD website, the package that will have a name like EladRemote-1.77.tgz.

For convenience, suppose it was downloaded to /tmp.

To install it you will need to open the terminal and then launch the commands:

```
sudo mkdir -p /usr/src  
cd /usr/src  
sudo tar xvzf /tmp/EladRemote-1.77.tgz
```

If the file has been downloaded to another folder, for example /home/giovanni/Downloads, just change the command appropriately; in this case you will do:

```
sudo tar xvzf /home/giovanni/Downloads/EladRemote-1.77.tgz
```

#### Installation of support libraries

You have to make sure that all the necessary support libraries are installed; to do this, use the command:

```
sudo apt-get install libftgl-dev freeglut3-dev libportaudio2 portaudio19-dev libopus-dev pkg-config  
libglib2.0-dev libssl-dev libpng-dev libusb-1.0-0-dev
```

#### Program compilation and installation

To compile and install EladRemote do:

```
cd /usr/src/EladRemote  
sudo make clean all install
```

This leads to a folder named /opt/EladRemote with all the stuff required to run EladRemote.



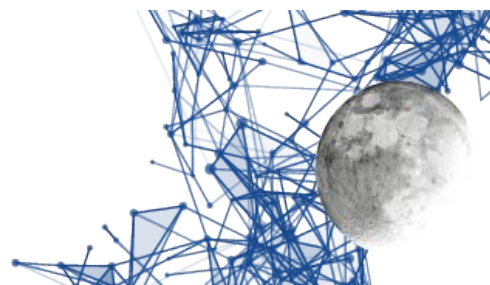

## Preparation of the execution environment

It may be useful to copy the `/opt/EladRemote/EladRemote.sh` file into a folder contained in the `PATH` so that you can launch `EladRemote.sh` from where you wish. This is done with the commands:

```
sudo cp /opt/EladRemote/EladRemote.sh /usr/bin
sudo chmod 755 /usr/bin/eladRemote.sh
```

You can link `EladRemote.sh` to any "launcher" of the graphical environment so that you can launch the program with a simple click.

## EladRemote first launch and configuration

Once the program has been installed, it must be launched the first time with appropriate parameters to let it memorize both the IP address of the DUO ART to be commanded and the corresponding password.

The simplest way is to use the commands:

```
cd /opt/EladRemote
./EladRemote xxx.yyy.zzz.www pppppppp tttt
```

where `xxx.yyy.zzz.www` is the IP address used to connect the DUO ART, `pppppppp` is the password that can be read on the display of the DUO ART using the "Set" menu under "6 MODALITY Remote Password", and `tttt` is the port number on which `EladRemote` communicates with DUO ART, (now this value is fixed to 6666).

Once the program is launched, when it is finished (with the ESC key or with a click on the exit button on the upper right corner of the window) the program saves in the file `/opt/EladRemote/init.txt` the two values together with all the default values of the "local" settings. Therefore it will not be necessary to launch the program a second time with the two parameters just seen, unless, for some reason, they are changed (physical transfer of the DUO ART, change of the password).

## EladRemote normal launch process

The simplest way is to use the commands:

```
cd /opt/EladRemote
./EladRemote
```

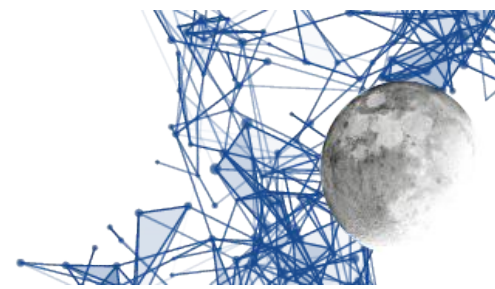

## Installation on Windows 64 bit systems

### Updating a previous version

If you are making an upgrade, the CYGWIN environment is already correct, you can go straight to the section [Installation of EladRemote](#).

### Preparation of the support environment

To use EladRemote in the Windows environment, the CYGWIN environment is used, which allows you to write and run programs designed for Linux in the Windows environment.

This environment is downloaded from [https://cygwin.com/setup-x86\\_64.exe](https://cygwin.com/setup-x86_64.exe).

At this URL you download an executable that, when run, will try to use administrator privileges to install about 100 Mbytes of basic executables.

At the URL <https://cygwin.com/install.html> there are detailed instructions, covering many different aspects.

**Please consider to download the setup program (setup-x86\_64.exe) on your Desktop, to be sure to know where it is when you need to launch it.**

*You can download this program in a folder of your choice, but the following installation instructions consider that the setup program was downloaded on Desktop, so, if you use another folder, remember to act accordingly.*

To prepare the environment you have to download a batch command from the ELAD website. This command is used to launch setup-x86\_64.exe with the proper parameters.

It is named setup.bat, and it is in the win64 subfolder of the folder containing this manual.

**Please download this program on the same folder of the setup program (setup-x86\_64.exe), normally on your Desktop**

*You cannot download this program in a folder of your choice, because this program assumes that the setup program (setup-x86\_64.exe) is in the same folder.*

This program, once launched, launches the setup program (setup-x86\_64.exe) with a list of packages that must be installed, but you have to walk through a series of windows that let you decide some configurations, as in the following pages.

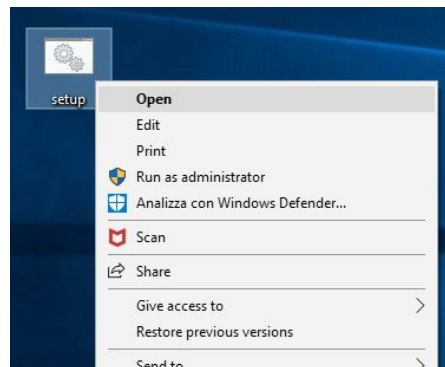
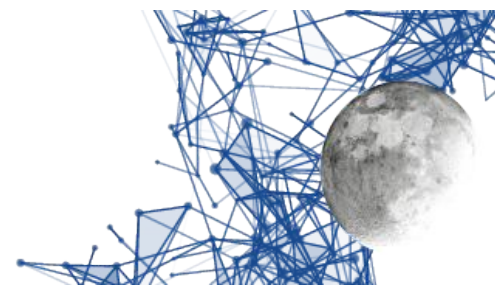

*Installation program – setup launch*

Once launched, and confirmed the use of Administrator privileges, the installation program looks like the image below:

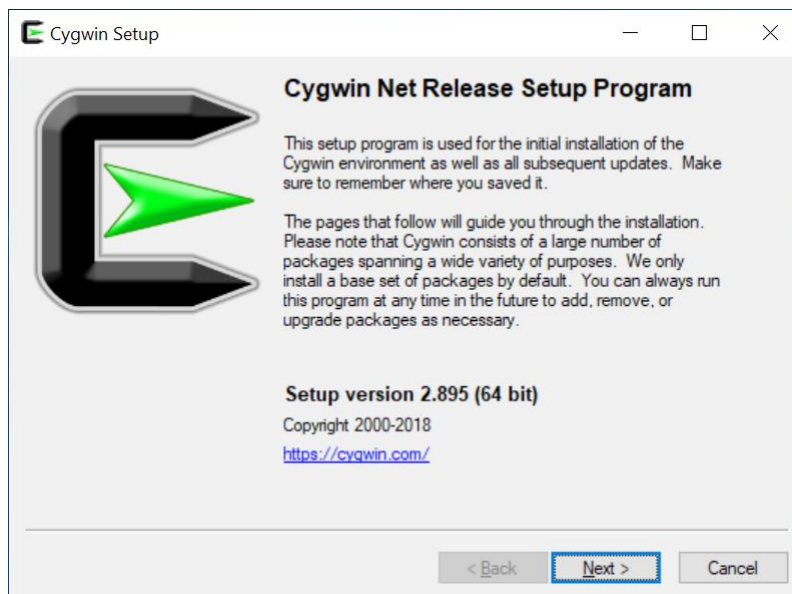

*Installation program - initial screen*

Once the decision to proceed is confirmed, the choice of installation mode appears, being able to download tarballs first and then proceed with the installation. We recommend that you confirm the download and installation in one step.

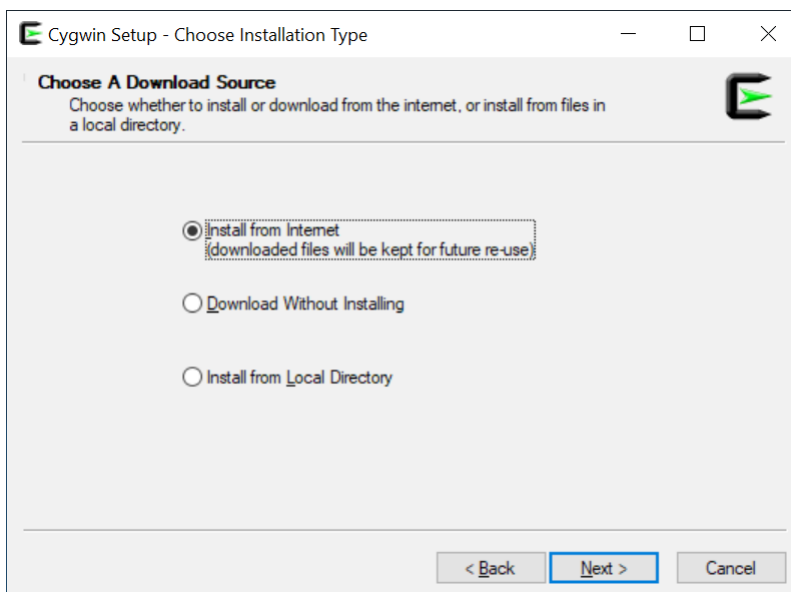
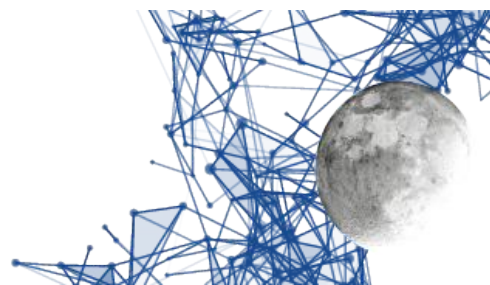

*Installation program - choice of operations*

The next choice is the folder where all CYGWIN stuff is to be installed. It is strongly suggested to confirm the proposed folder, that is c:\cygwin64 for 64 bits systems, in order to make any assistance easier.

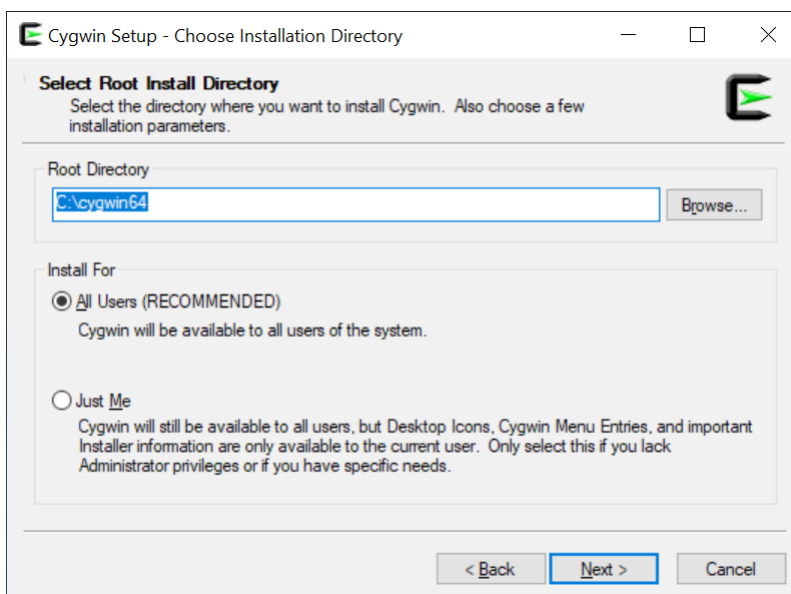

*Installation program – installation folder*

Now it is necessary to indicate where to save the installation files, also here it is better to confirm the proposed choice which is equivalent to the creation of a folder on the user's Desktop.

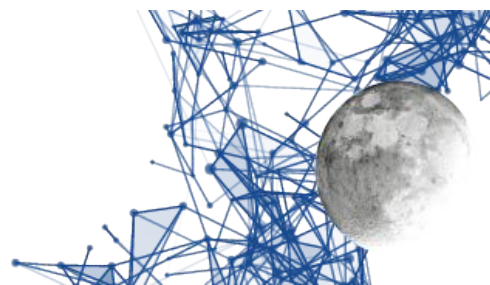

*Installation program - where to store the installation files*

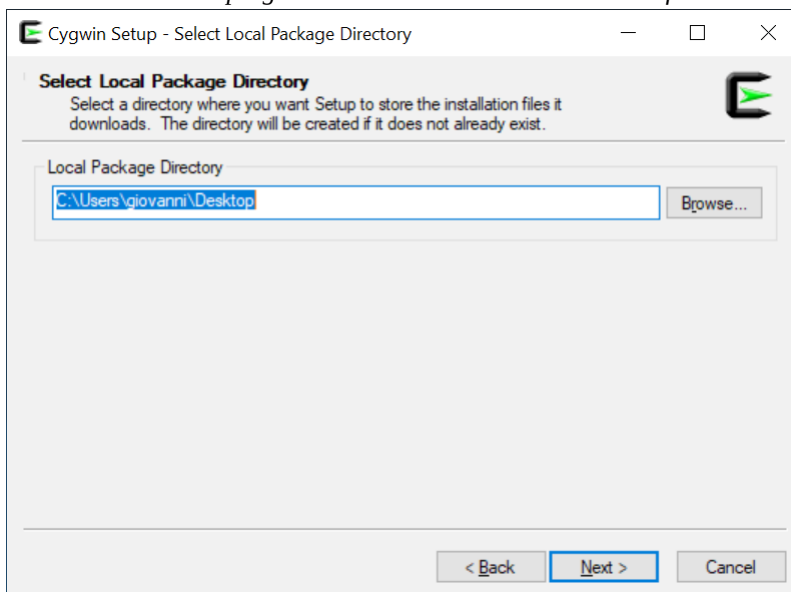

In the next step you have to choose the type of connection used to download the files. Unless there are special needs, the proposed default choice is the best one.

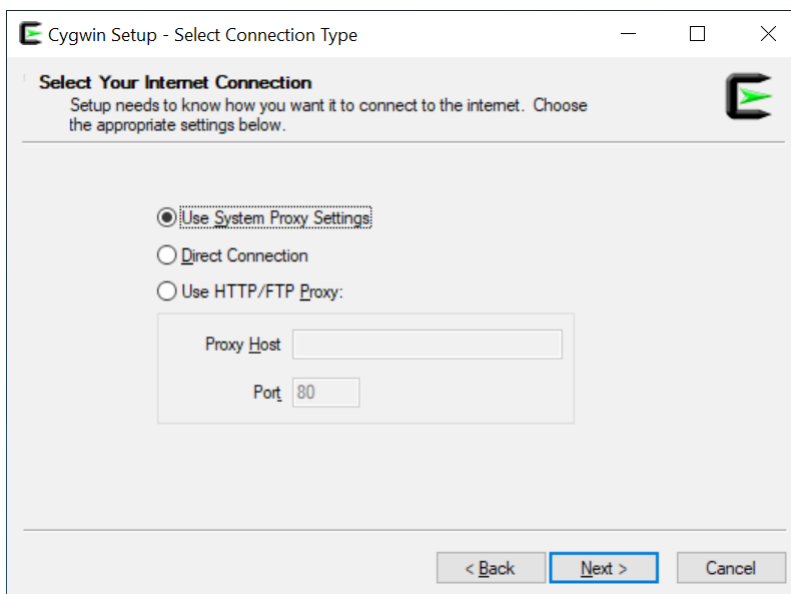

*Installation program - network configuration for downloading*

In the next step you can choose which mirror to use, selecting it from a list. You can keep the default choice unless you notice that the data is being downloaded too slowly.

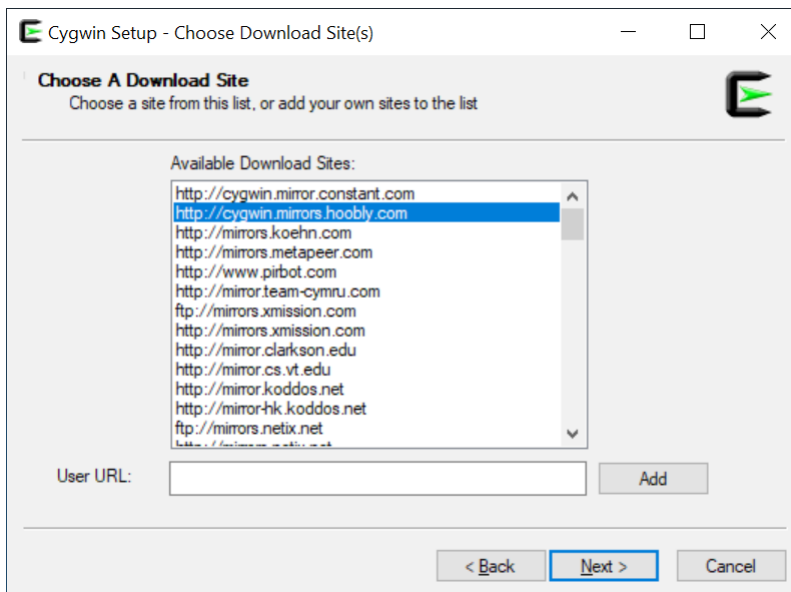
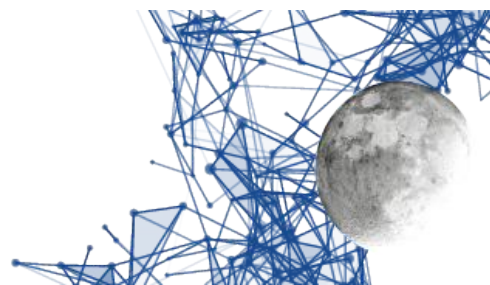

*Installation program - choice of the mirror*

At this point you will see the first download phase of the data necessary for the installation. This is basically the package list and the download does not take much time.

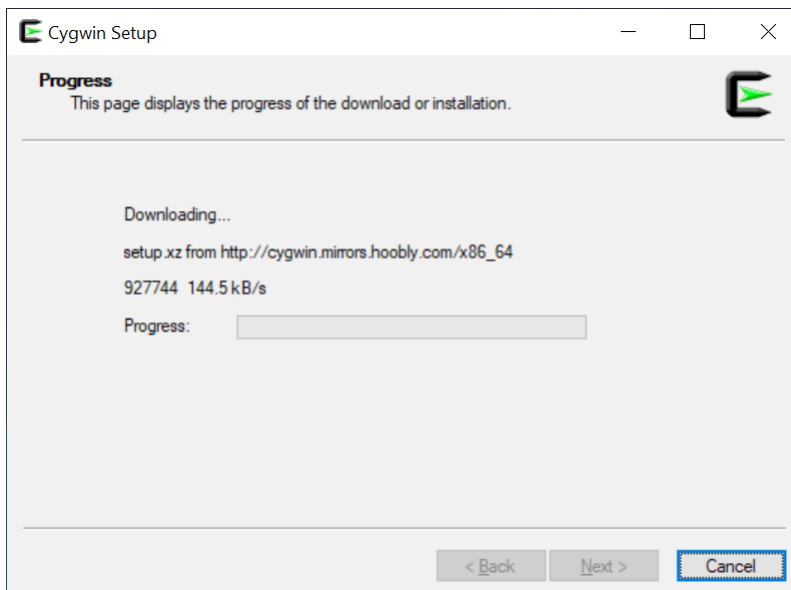

*Installation program - download of the list of installable packages*

In this phase you could be warned that the downloaded version is not the most updated. If you have just downloaded the installer this will hardly appear, but if you are using a previously downloaded installer this alert might appear. In any case, you must confirm to proceed.

You can still proceed with the installation without updating and in any case everything will work. However, if you prefer to use the latest version, then, as soon as you click OK, when the next screen appears, click the "Cancel" button and download the installation program again to restart the installation.



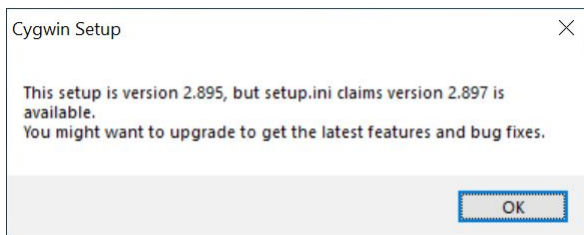
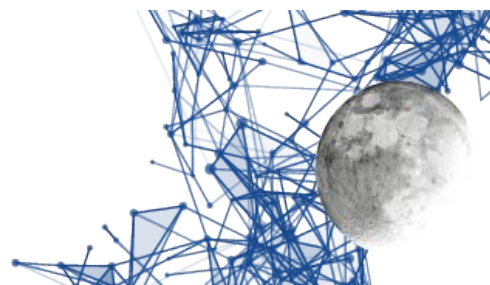

Installation program - possible updated version notice available

Once the list of available packages has been downloaded, the screen with the list of all the packages that can be selected for installation will appear.

**You don't need to choose anything because the main packages that the installation needs are preselected, so just click the "Next" button to proceed with the installation of what is necessary.**

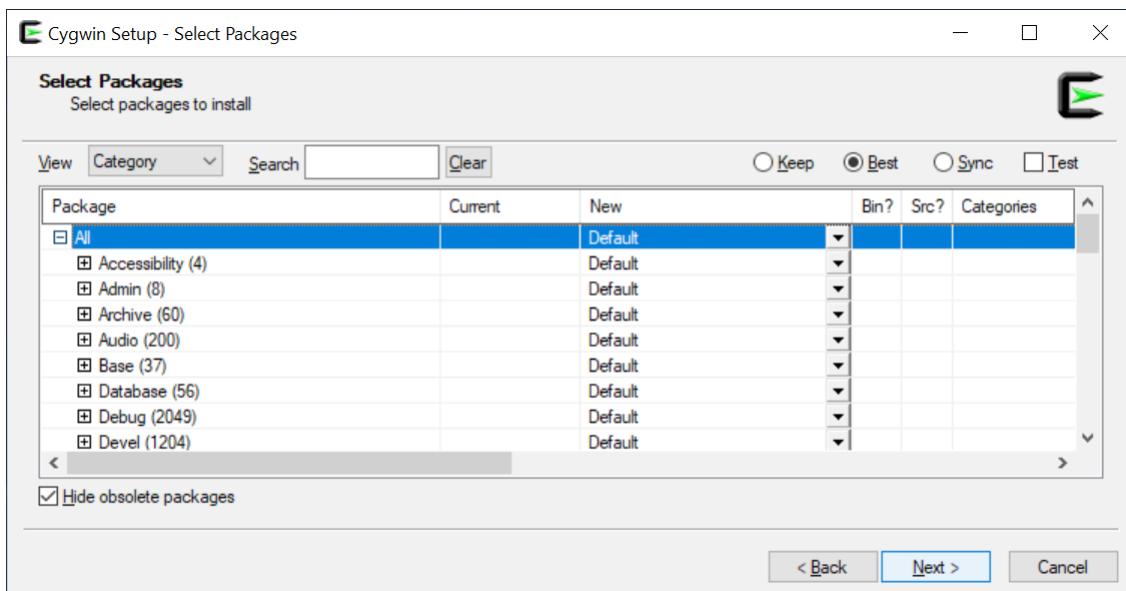

Installation program - list of packages to be installed

At this point the installation program presents a list of the selected packages and asks for confirmation; click to proceed with the download and installation.

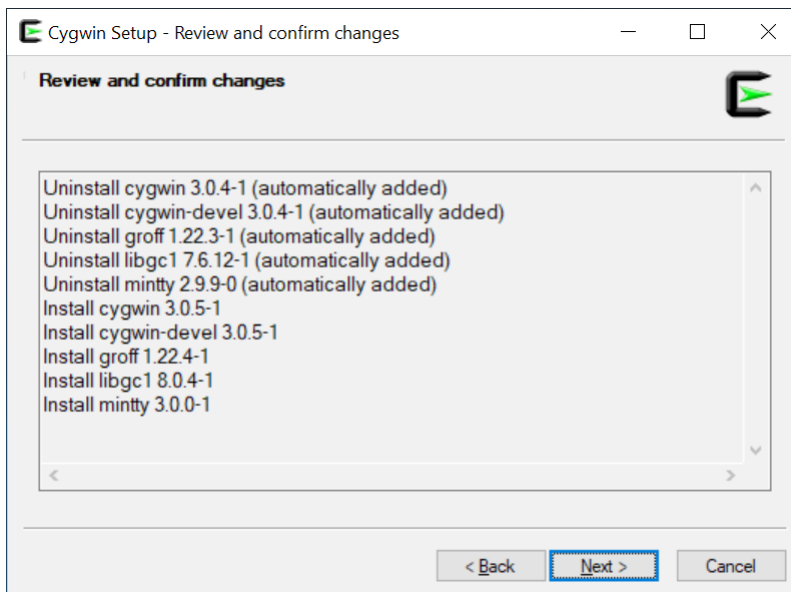
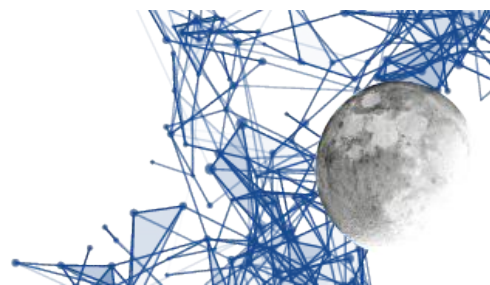

*Installation program - confirm packages to install*

The installer will show the progress of the operations, using various progress bars. This operation will take some time, so it is useful to arm yourself with a little patience.

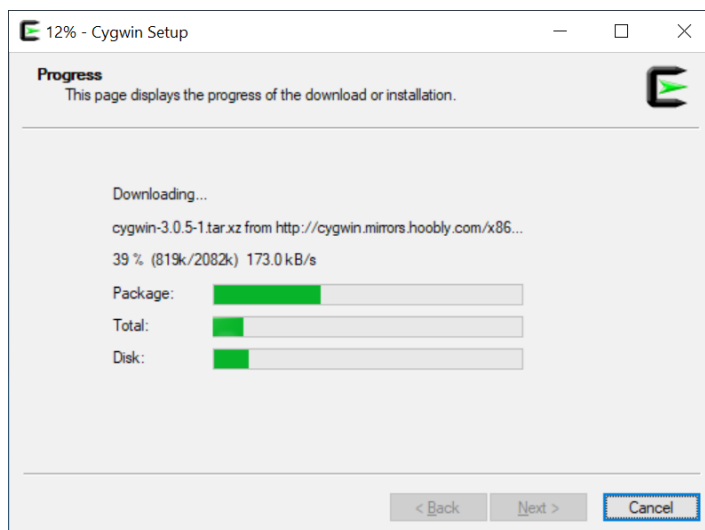

*Installation program - progress of operations*

There may be a warning about the need to restart the PC. Confirm by clicking OK and then proceed without problems, restarting when the installation is finished.

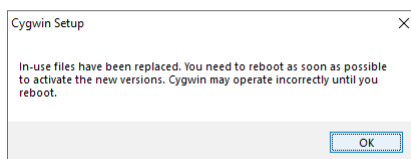

*Installation program - possible restart request*

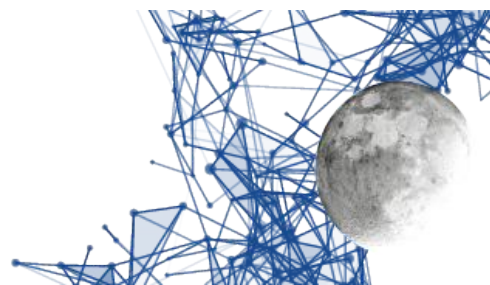

At this stage, you may still see a progress window for the configuration of the packages. Even here it is a matter of patiently waiting for the operations to end.

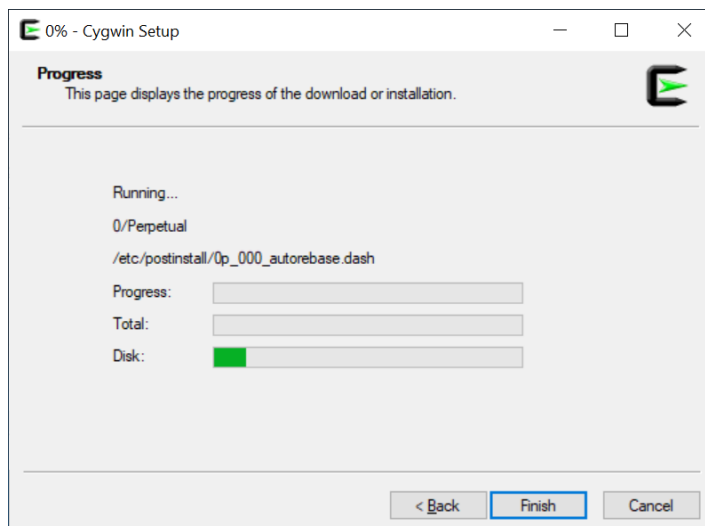

*Installation program - last installation phase*

The last step is when the installation program creates the icons on the desktop and in the menu (highly recommended choice).

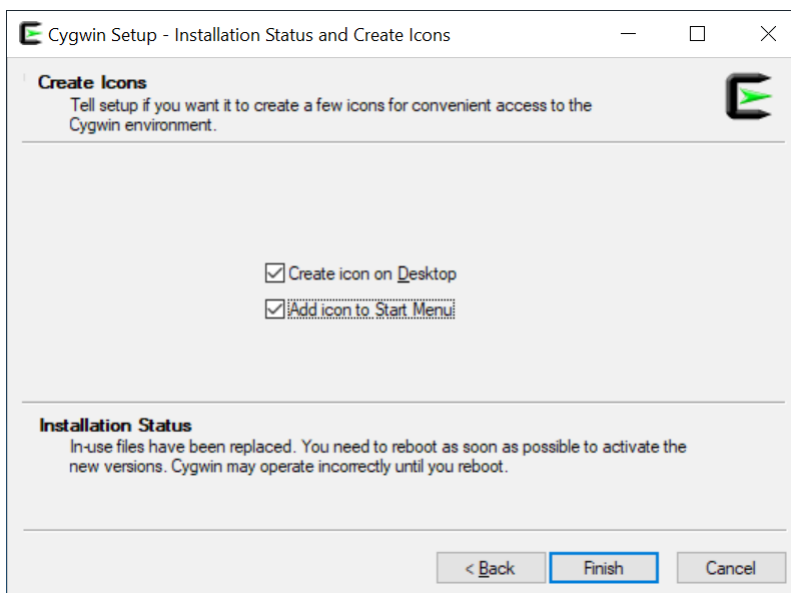

*Installation program - menu and icon creation*

At this point the first installation phase is over. Probably more time was needed to read this presentation than to perform the indicated operations. Now there will be two icons on the desktop: one relating to the installation program, the other relating to the terminal you have to use to write commands inside the CYGWIN environment.

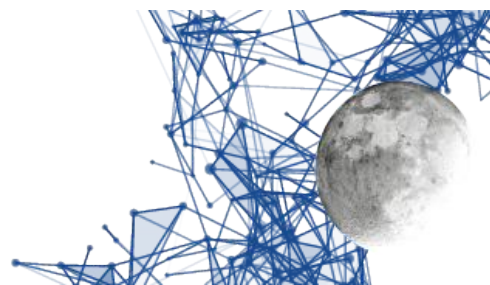

## Installation of EladRemote

EladRemote is contained in a zip file, downloadable from the Elad site, at the URL win64/Win64EladRemote-1.77.zip.

Also in this case the downloaded file must be copied to the main cygwin folder, that is in C:\cygwin64 (unless a different folder has been chosen in the first phases of installation).

To install all the files in the proper directory you have to extract all from this zipfile using the following procedure.

Download the file into your computer, the browser normally download file into Download folder. Use the file manager to open your Download folder to see the Win64EladRemote-1.77.zip icon.

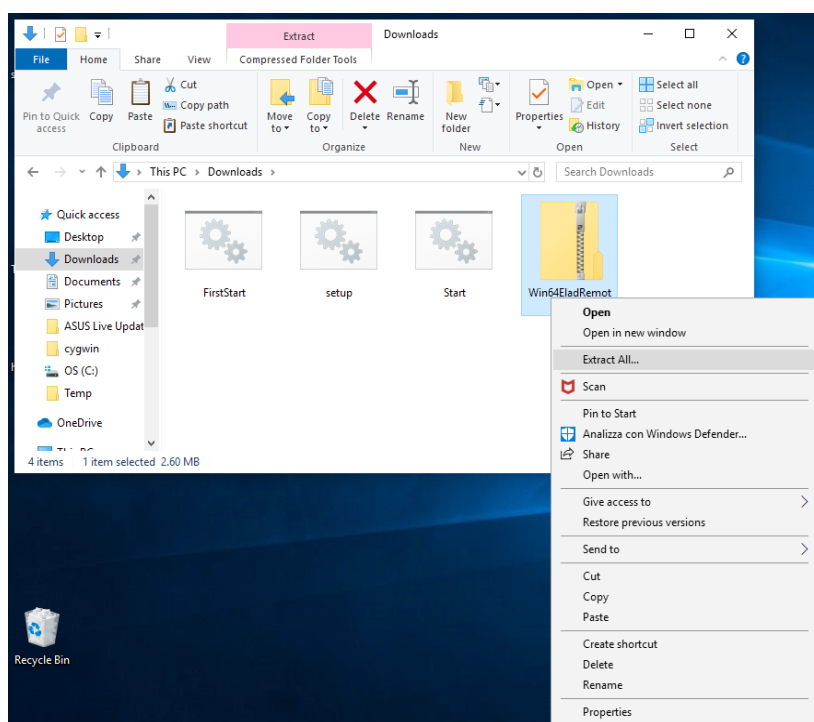

EladRemote program installation – open Download folder

Right click on the Win64EladRemote-1.77.zip icon to open the pop-up menu and choose “Extract All” to extract all the files in a specified location.

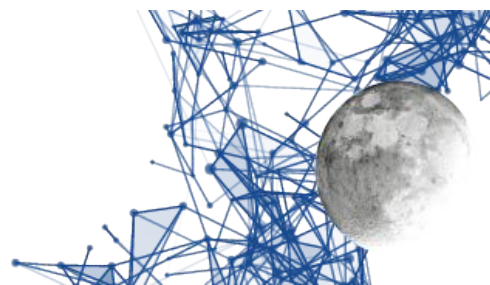

Choose the location C:\cygwin64 and confirm the extraction.

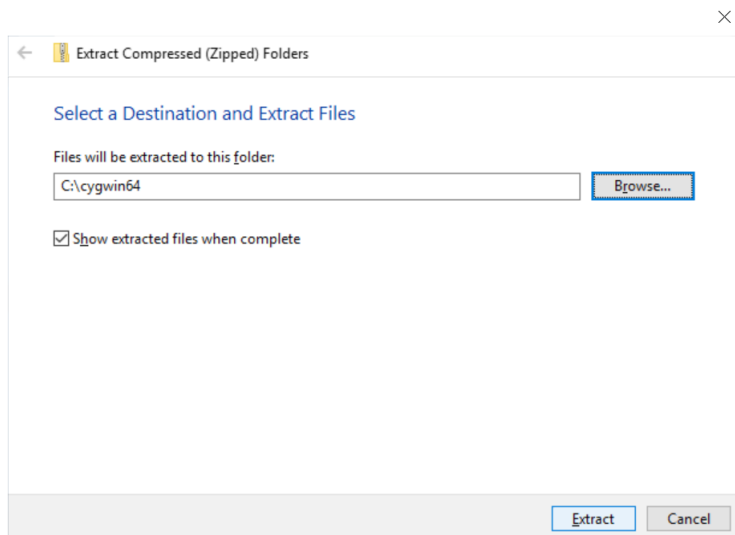

EladRemote program installation – choose the right location

Close the window: this part of the installation is finished.

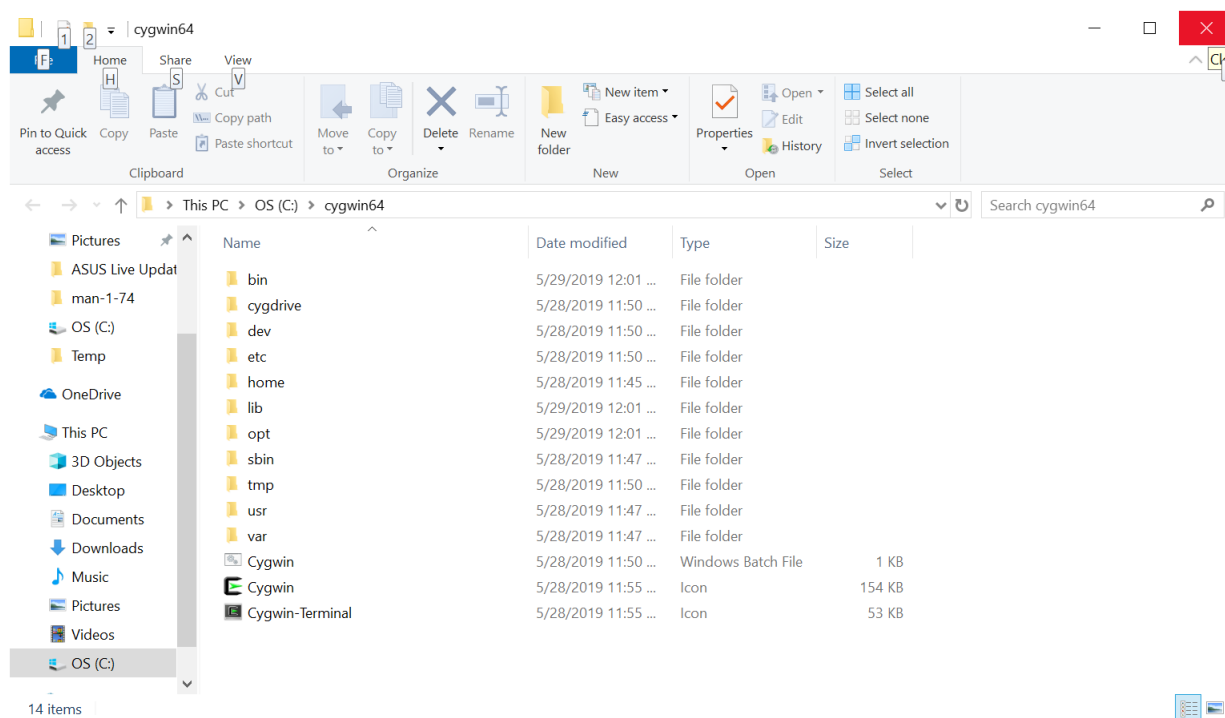

EladRemote program installation – installation finished



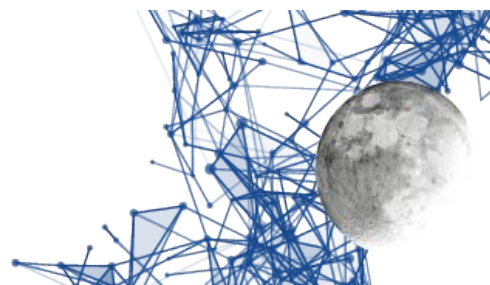

## EladRemote first launch and configuration

The first launch and configuration of EladRemote is done by downloading another batch file named FirstStart.bat. This file is in the win64 subfolder of the folder containing this manual. Place this file in the Desktop so you are able to launch EladRemote with the usual double click.

When launching this batch file you'll be asked to give some informations:

- The IP address where your DUO ART could be reached, or the name resolved by DNS, DYNDNS, or /etc/hosts file of your computer.
- The Passphrase as displayed on Menu 6 of the DUO ART
- The port (at the moment you must use 6666)

The values are saved in /opt/EladRemote/init.txt file at the first exit from the EladRemote program, so the FirstStart batch command is needed only the very first time and any time you need to change one of this three parameters.

## EladRemote normal launch process

The EladRemote program is launched by using another batch file named start.bat, that should be downloaded from the win64 folder of the Elad subfolder of the folder containing this manual. Place this file in the Desktop so you are able to launch EladRemote with the usual double click .

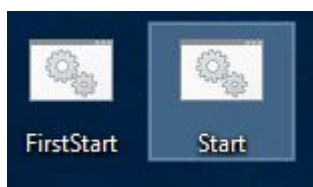

*The Desktop icons to launch EladRemote*

**Attention must be paid to the behavior of your antivirus so that it does not block the start-up of both Cygwin and the EladRemote application. The operations to be performed depend on the antivirus installed, please refer to the manual of your antivirus.**

**Note: starting with this version the window of EladRemote can be resized using the gadget in the top right corner of the titlebar. Since some odds with TWM (the Cygwin window manager) to downsize this windows you must start increasing the dimansion, then, without releasing the mouse button, you can reduce the dimensions.**

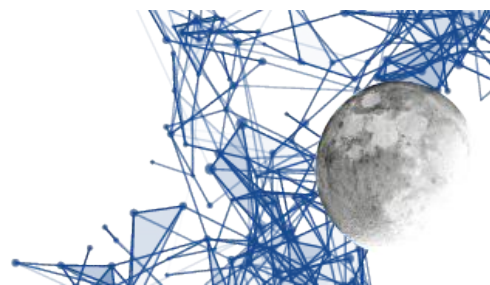

## Installation on Windows 32 bit systems

### Updating a previous version

If you are making an upgrade, the CYGWIN environment is already correct, you can go straight to the section [Installation of EladRemote](#).

### Preparation of the support environment

To use EladRemote in the Windows environment, the CYGWIN environment is used, which allows you to write and run programs designed for Linux in the Windows environment.

This environment is downloaded from <https://cygwin.com/setup-x86.exe>.

At this URL you download an executable that, when run, will try to use administrator privileges to install about 100 Mbytes of basic executables.

At the URL <https://cygwin.com/install.html> there are detailed instructions, covering many different aspects.

**Please consider to download the setup program (setup-x86.exe) on your Desktop, to be sure to know where it is when you need to launch it.**

*You can download this program in a folder of your choice, but the following installation instructions consider that the setup program was downloaded on Desktop, so, if you use another folder, remember to act accordingly.*

To prepare the environment you have to download a batch command from the ELAD website. This command is used to launch setup-x86.exe with the proper parameters.

It is named setup.bat, and it is in the win32 subfolder of the folder containing this manual.

**Please download this program on the same folder of the setup program (setup-x86\_64.exe), normally on your Desktop**

*You cannot download this program in a folder of your choice, because this program assumes that the setup program (setup-x86.exe) is in the same folder.*

This program, once launched, launches the setup program (setup-x86.exe) with a list of packages that must be installed, but you have to walk through a series of windows that let you decide some configurations, as in the following pages.

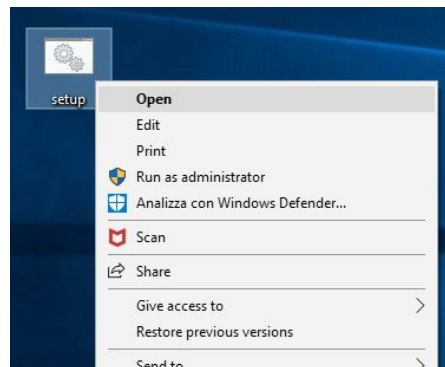
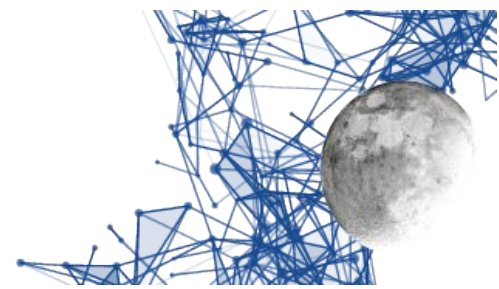

*Installation program – setup launch*

Once launched, and confirmed the use of Administrator privileges, the installation program looks like the image below:

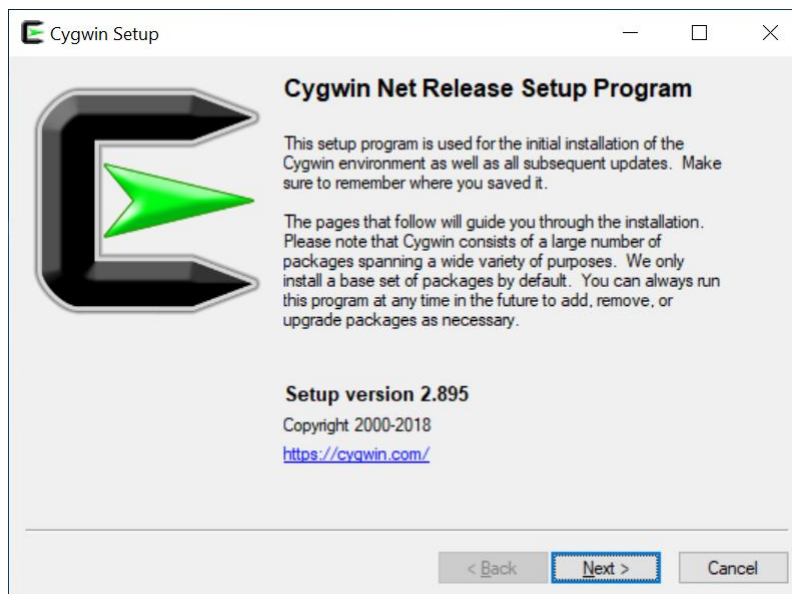

*Installation program - initial screen*

Once the decision to proceed is confirmed, the choice of installation mode appears, being able to download tarballs first and then proceed with the installation. We recommend that you confirm the download and installation in one step.

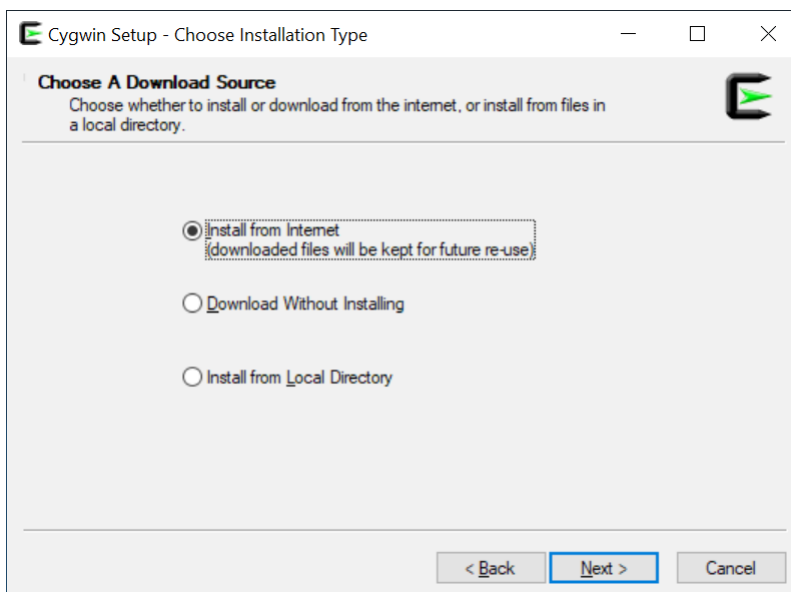
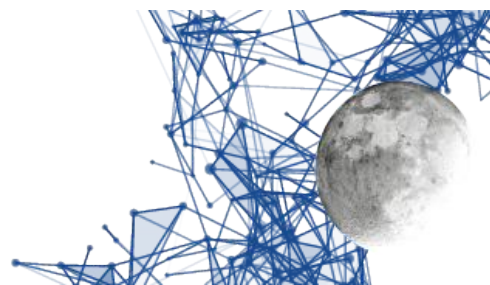

*Installation program - choice of operations*

The next choice is the folder where all CYGWIN stuff is to be installed. It is strongly suggested to confirm the proposed folder, that is c:\cygwin for 32 bits systems, in order to make any assistance easier.

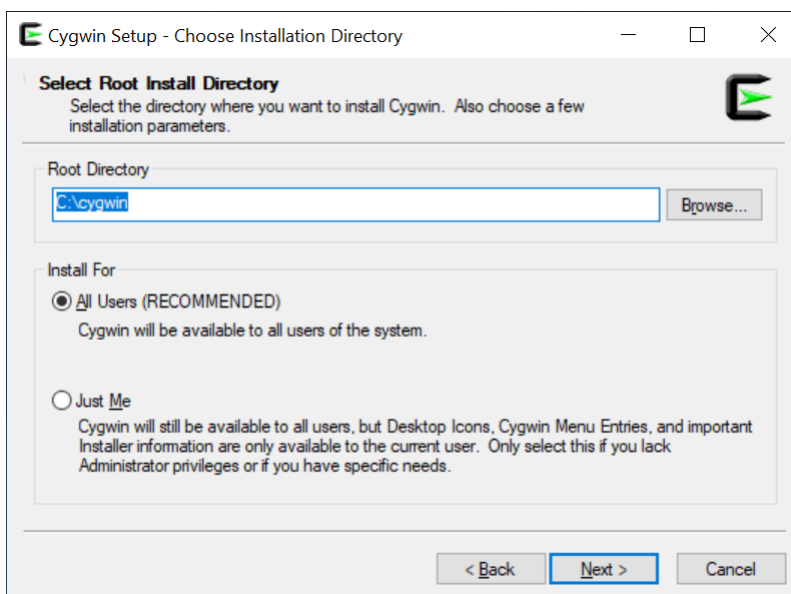

*Installation program – installation folder*

Now it is necessary to indicate where to save the installation files, also here it is better to confirm the proposed choice which is equivalent to the creation of a folder on the user's Desktop.

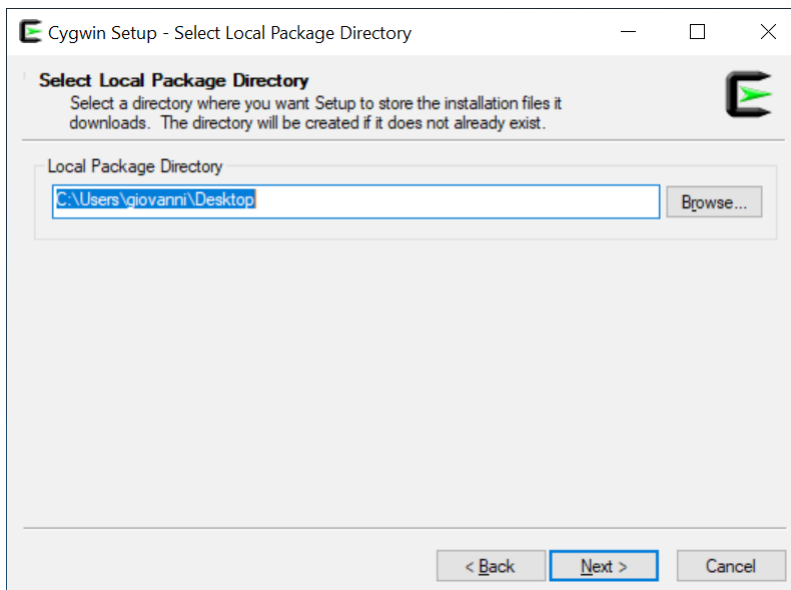
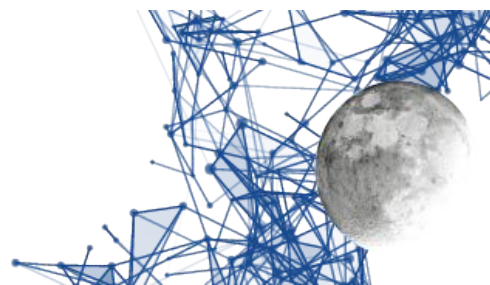

*Installation program - where to store the installation files*

In the next step you have to choose the type of connection used to download the files. Unless there are special needs, the proposed default choice is the best one.

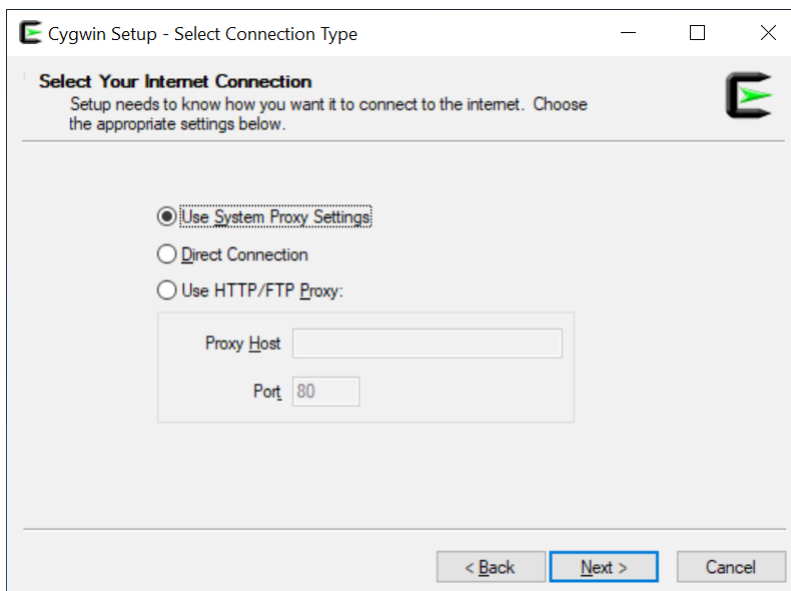

*Installation program - network configuration for downloading*

In the next step you can choose which mirror to use, selecting it from a list. You can keep the default choice unless you notice that the data is being downloaded too slowly.



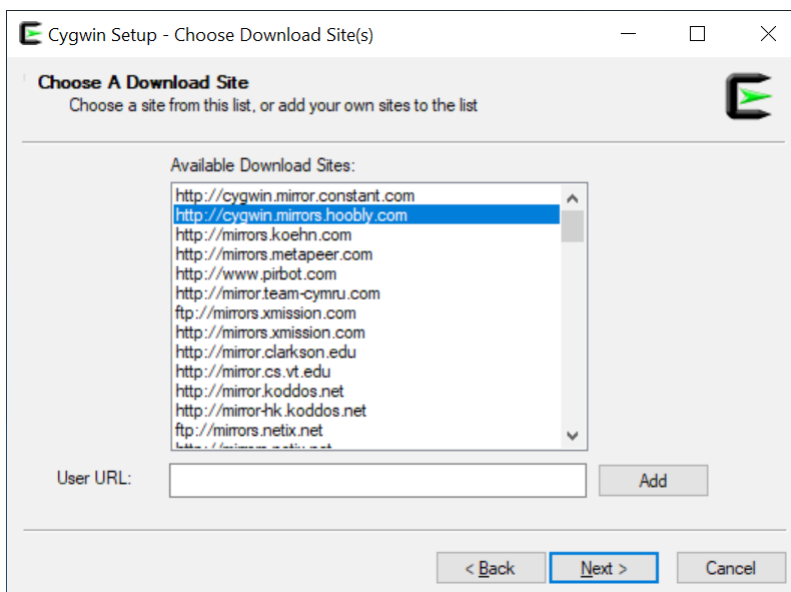
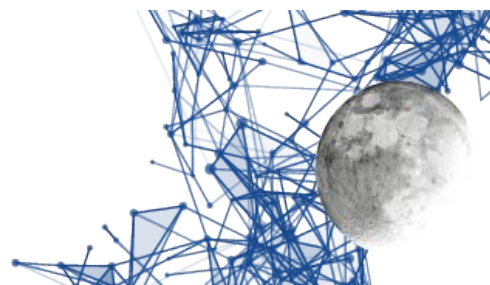

*Installation program - choice of the mirror*

At this point you will see the first download phase of the data necessary for the installation. This is basically the package list and the download does not take much time.

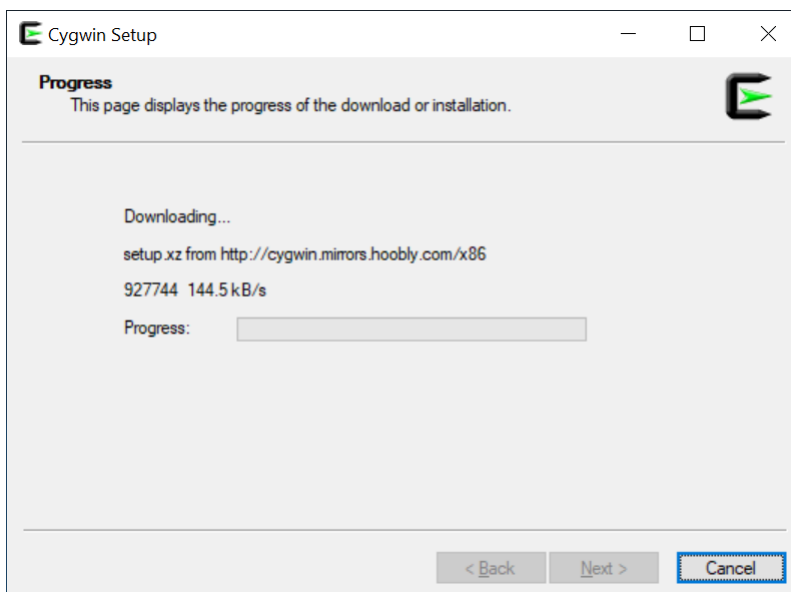

*Installation program - download of the list of installable packages*

In this phase you could be warned that the downloaded version is not the most updated. If you have just downloaded the installer this will hardly appear, but if you are using a previously downloaded installer this alert might appear. In any case, you must confirm to proceed.

You can still proceed with the installation without updating and in any case everything will work. However, if you prefer to use the latest version, then, as soon as you click OK, when the next screen appears, click the "Cancel" button and download the installation program again to restart the installation.

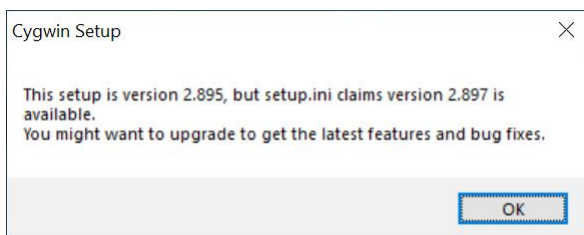
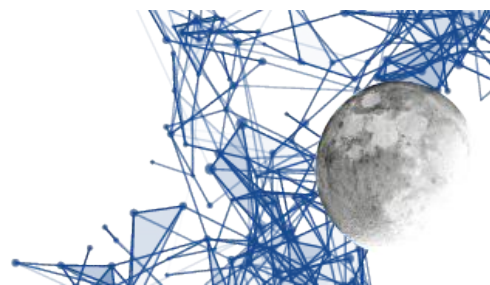

Installation program - possible updated version notice available

Once the list of available packages has been downloaded, the screen with the list of all the packages that can be selected for installation will appear.

**You don't need to choose anything because the main packages that the installation needs are preselected, so just click the "Next" button to proceed with the installation of what is necessary.**

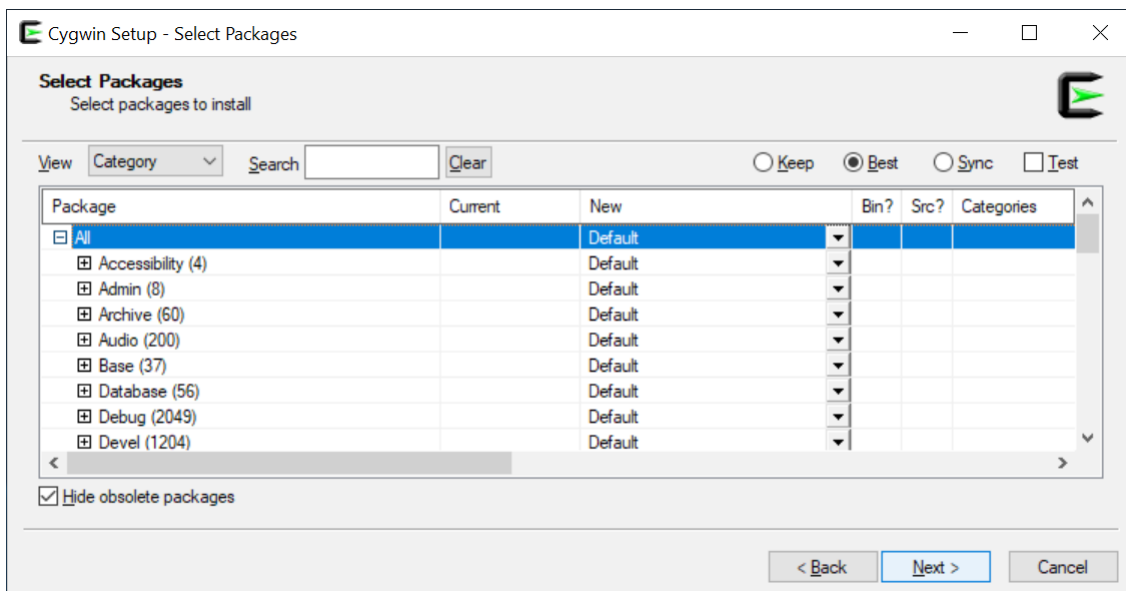

Installation program - list of packages to be installed

At this point the installation program presents a list of the selected packages and asks for confirmation; click to proceed with the download and installation.

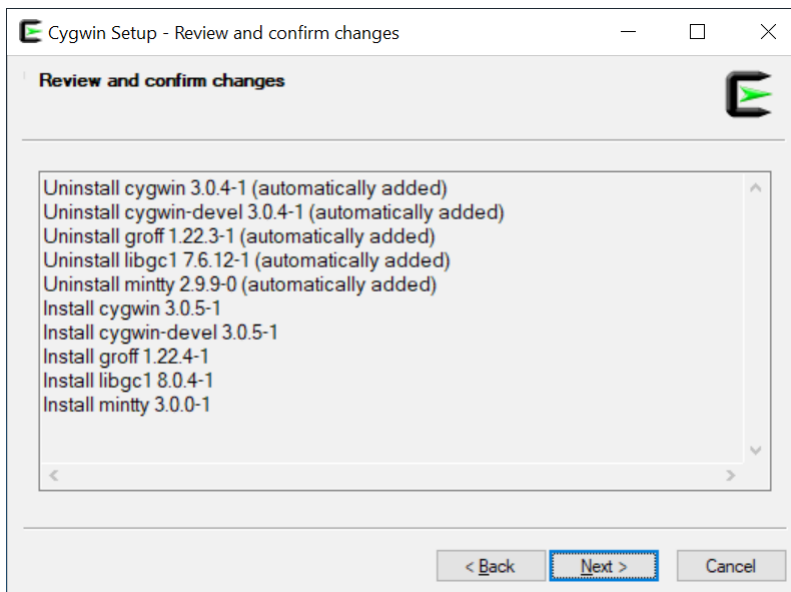
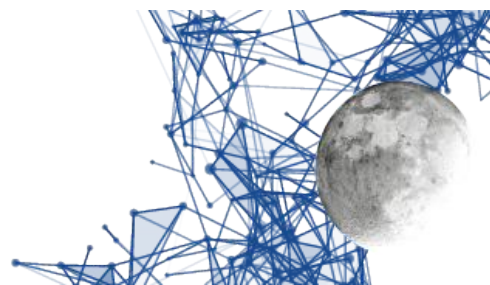

*Installation program - confirm packages to install*

The installer will show the progress of the operations, using various progress bars. This operation will take some time, so it is useful to arm yourself with a little patience.

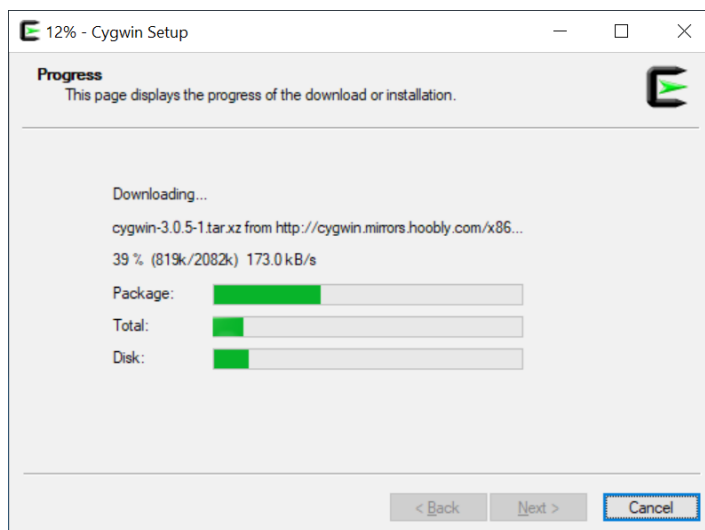

*Installation program - progress of operations*

There may be a warning about the need to restart the PC. Confirm by clicking OK and then proceed without problems, restarting when the installation is finished.

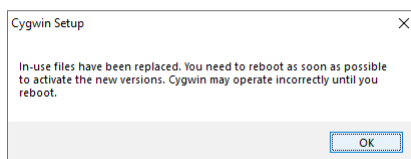

*Installation program - possible restart request*

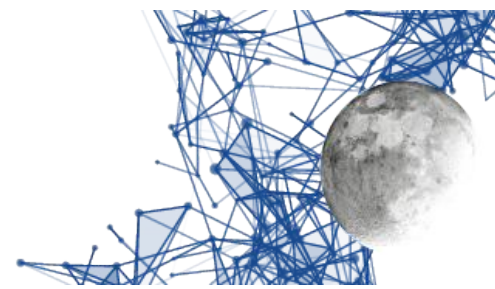

At this stage, you may still see a progress window for the configuration of the packages. Even here it is a matter of patiently waiting for the operations to end.

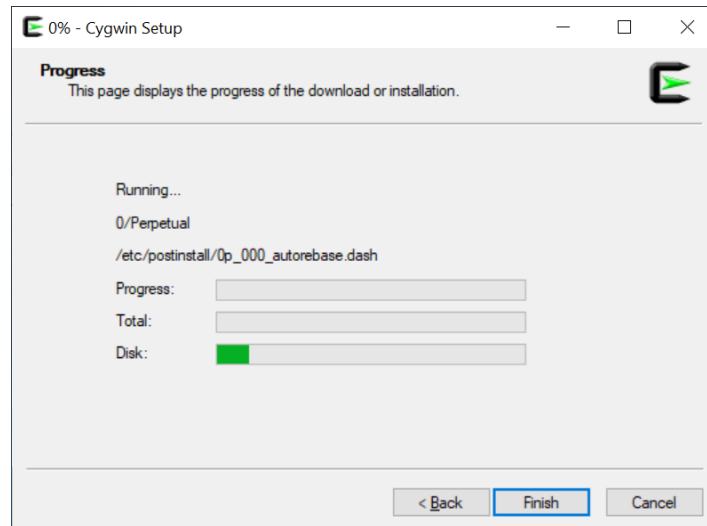

*Installation program - last installation phase*

The last step is when the installation program creates the icons on the desktop and in the menu (highly recommended choice).

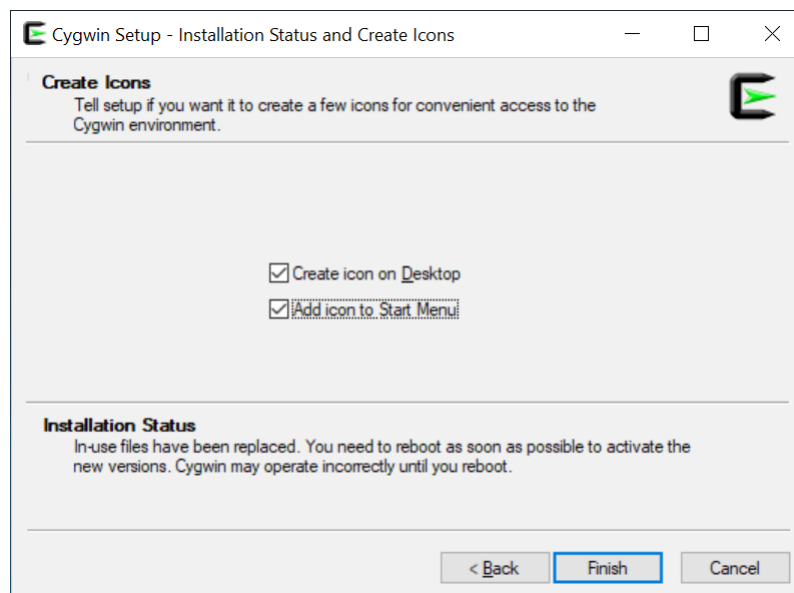

*Installation program - menu and icon creation*

At this point the first installation phase is over. Probably more time was needed to read this presentation than to perform the indicated operations. Now there will be two icons on the desktop: one relating to the installation program, the other relating to the terminal you have to use to write commands inside the CYGWIN environment.

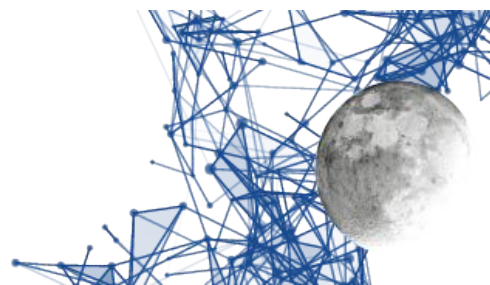

## Installation of EladRemote

EladRemote is contained in a zip file, downloadable from the Elad site, at the URL [win32/Win32EladRemote-1.77.zip](http://win32/Win32EladRemote-1.77.zip).

Also in this case the downloaded file must be copied to the main cygwin folder, that is in C:\cygwin (unless a different folder has been chosen in the first phases of installation).

To install all the files in the proper directory you have to extract all from this zipfile using the following procedure.

Download the file into your computer, the browser normally download file into Download folder. Use the file manager to open your Download folder to see the Win32EladRemote-1.77.zip icon.

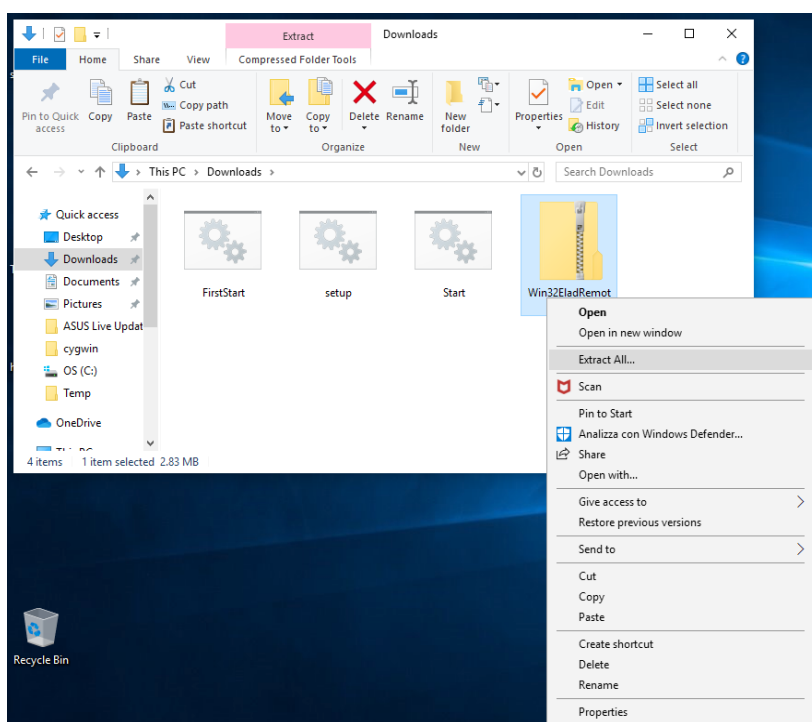

EladRemote program installation – open Download folder

Right click on the Win32EladRemote-1.77.zip icon to open the pop-up menu and choose “Extract All” to extract all the files in a specified location.



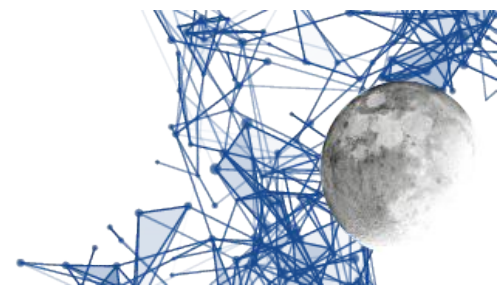

Choose the location C:\cygwin and confirm the extraction.

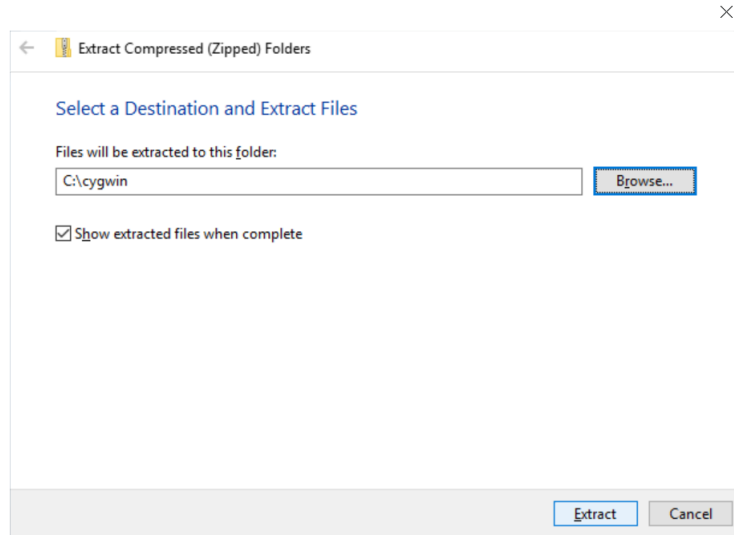

EladRemote program installation – choose the right location

Close the window: this part of the installation is finished.

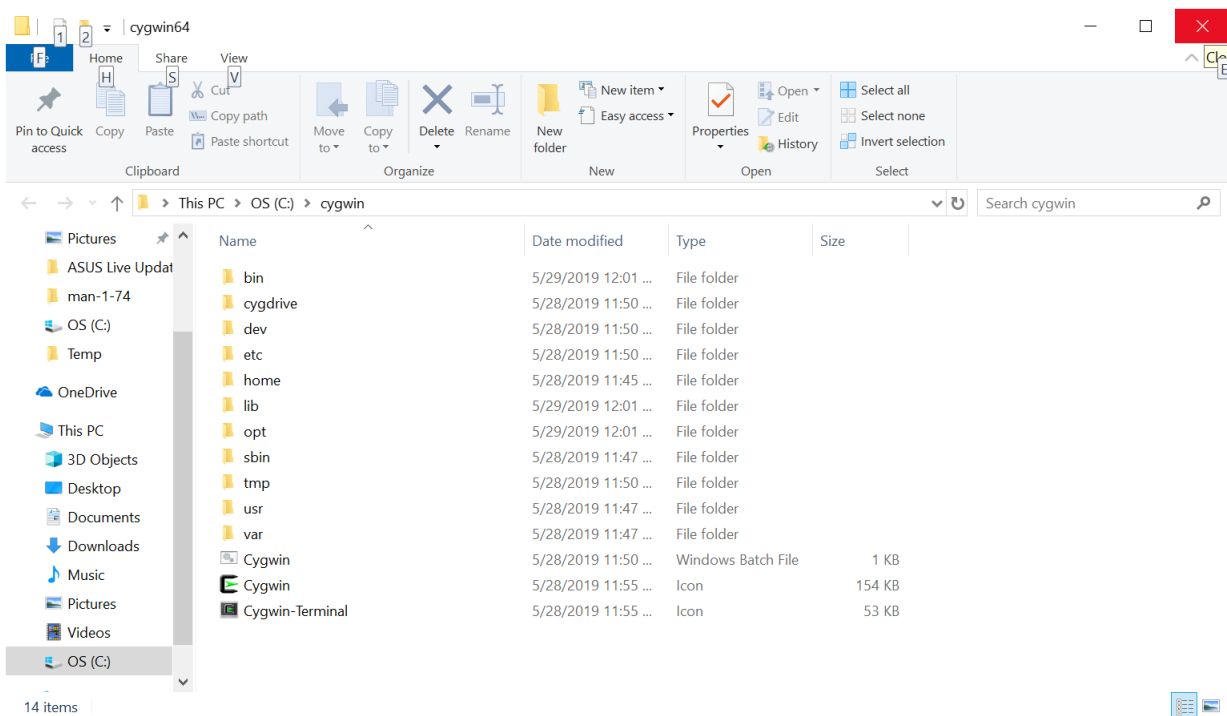

EladRemote program installation – installation finished

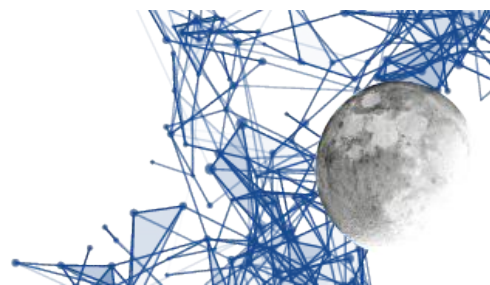

## EladRemote first launch and configuration

The first launch and configuration of EladRemote is done by downloading another batch file named FirstStart.bat. This file is in the win32 subfolder of the folder containing this manual. Place this file in the Desktop so you are able to launch EladRemote with the usual double click.

When launching this batch file you'll be asked to give some informations:

- The IP address where your DUO ART could be reached, or the name resolved by DNS, DYNDNS, or /etc/hosts file of your computer.
- The Passphrase as displayed on Menu 6 of the DUO ART
- The port (at the moment you must use 6666)

The values are saved in /opt/EladRemote/init.txt file at the first exit from the EladRemote program, so the FirstStart batch command is needed only the very first time and any time you need to change one of this three parameters.

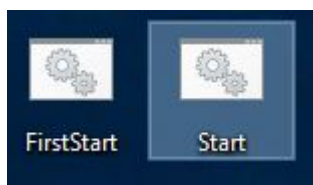

*The Desktop icons to launch EladRemote*

## EladRemote normal launch process

The EladRemote program is launched by using another batch file named start.bat, that should be downloaded from the win32 folder of the Elad subfolder of the folder containing this manual. Place this file in the Desktop so you are able to launch EladRemote with the usual double click .

**Attention must be paid to the behavior of your antivirus so that it does not block the start-up of both Cygwin and the EladRemote application. The operations to be performed depend on the antivirus installed, please refer to the manual of your antivirus.**

**Note: starting with this version the window of EladRemote can be resized using the gadget in the top right corner of the titlebar. Since some odds with TWM (the Cygwin window manager) to downsize this windows you must start increasing the dimansion, then, without releasing the mouse button, you can reduce the dimensions.**

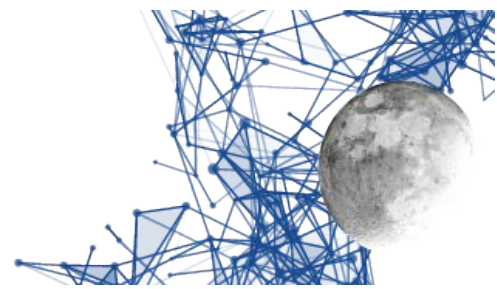

## Web folders schematics

All the software should be found on the ELAD website, in the folder:

[http://www.eladit.com/download/sdr/DUO-ART\\_EladRemote/v1.79/](http://www.eladit.com/download/sdr/DUO-ART_EladRemote/v1.79/)

this folder there contains the following tree:

- EladRemoteMan-1.77.en.pdf
- EladRemoteMan-1.77.it.pdf
- linux
- win64
  - Win64EladRemote-1.77.zip
  - setup.bat
  - FirstStart.bat
  - Start.bat
- win32
  - Win32EladRemote-1.77.zip
  - setup.bat
  - FirstStart.bat
  - Start.bat

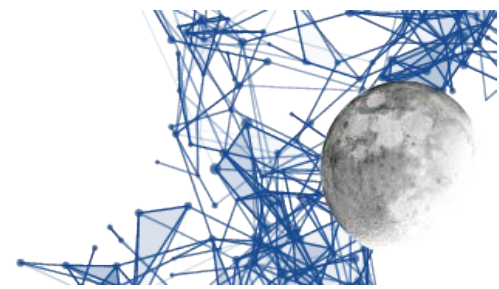

## Connections

### How to connect FDM DUO and DUO ART

This information can already be found in the DUO ART manual but is repeated here for ease of reference.

Normally FDM DUO and DUO ART are connected for what is called Local mode, in which the operator controls operations directly on the devices.

This connection mode requires fewer connections between FDM DUO and DUO ART and also allows the connection of FDM DUO with a PC where programs such as SW2 operate.

FDMDUO Interface - Local Setup

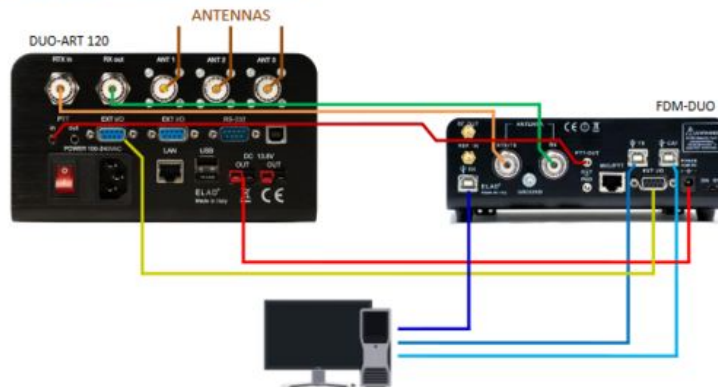

FDMDUO Interface - Remote Setup

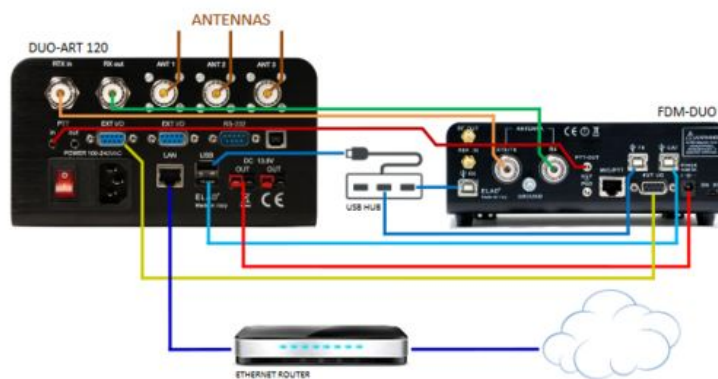

*FDM DUO / DUO ART connection schematics as per DUO ART Manual*

In the Remote mode all the USB connections of the FDM DUO should not be connected to the PC but to the DUO ART so that it can control the FDM DUO.

**Since the DUO ART must control the FDM DUO via CAT, remember to set the CAT speed of the FDM DUO to 115200 bps using menu 70.**